

C 50

www.hermle.de



Milling at its best: Hermle machines are often at the forefront when it comes to optimized results.

The proverbial Hermle precision in conjunction with process consultation and project management has made us an important machine manufacturer in nearly all key sectors: from large complex components to the smallest components in the high-tech area. Versatile applications, uncompromising results – Hermle “The Original”.

www.hermle.de/milling



Contents.

01 Industry sectors	6
02 The machine	10
03 Technical data	44
04 Automation	56
05 Precision	62
06 Energy efficiency	64
07 Services	66



01 Industry sectors

Hermle is at home in all sectors. For us, ensuring the highest precision and reliable machining is always paramount. Our machines are made for daily operation, whether as linked linear segments in production or as stand-alone workshop machinery.

www.hermle.de/sectors

Aerospace industry



Machine construction

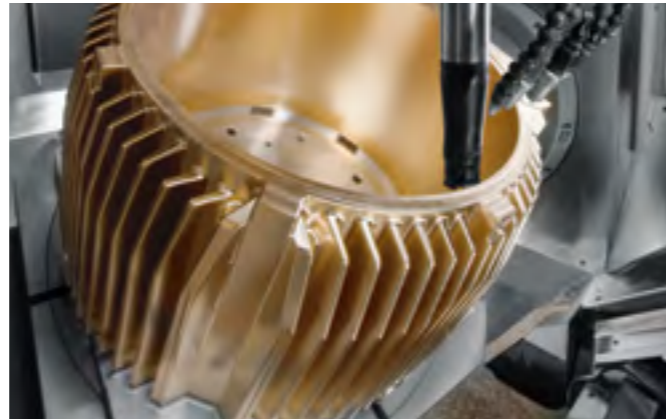

Energy Technology

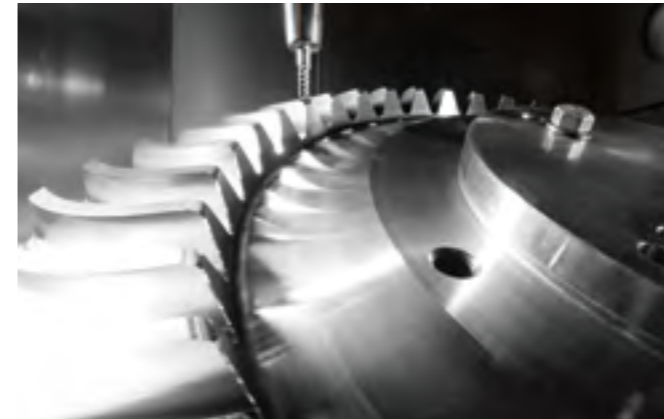

Tool and mould construction



Subcontractor industry



01.1 Applications

Dynamic, precise and reliable Hermle's C 50 can provide highly dynamic processing of workpieces up to 2000 kg in weight simultaneously in 5 axes. In particular, materials which are difficult to machine can be milled in record time and with perfect precision. This is achieved fully automatically right up to entire flexible production systems. Our systems are always extremely precise and ensure high machine availability.

www.hermle.de/applications



Blisks

5-axis milling and turning

Sector: aerospace industry
Material: 1.2312
Tool: Face milling cutter/
porcupine cutter

Holding
fixture: HSK A 100
Spindle: 12000 rpm
Output/
torque: 356 Nm/56 kW

bottom



Spiral bevel wheel

5-axis milling

Sector: Large machine
manufacturing
Material: 1.6587
Tool: Form cutter
Holding
fixture: HSK A 63
Spindle: 18000 rpm
Output/
torque: 240 Nm/39 kW

top



Beer crate

5-axis milling

Sector: Metal products
Material: 1.2162
Tool: Form cutter
Holding
fixture: HSK A 63
Spindle: 18000 rpm
Output/
torque: 240 Nm/39 kW

left



Flange

5-axis milling and turning

Sector: Large machine
manufacturing
Material: GGG 40
Tool: Angular milling
cutter head/
Hi-Feed insert
milling cutter

Holding
fixture: HSK A 100
Spindle: 12000 rpm
Output/
torque: 356 Nm/56 kW

right



02 The machine

The C 50: a highly dynamic machining centre designed consistently for 5-axis/5-side machining.
Features galore to ensure high-precision, economical parts production. Numerous automation solutions extend the application range many times over.

www.hermle.de/c50/facts

TECHNICAL DATA

<i>Traverse X-Y-Z:</i>	1000 - 1100 - 750 mm
<i>Speed:</i>	9000 / 10000 / 12000 / 15000 / 18000 rpm
<i>Rapid linear traverses X-Y-Z:</i>	60 - 60 - 55 m/min
<i>Linear acceleration X-Y-Z:</i>	6 m/s ²
<i>Control unit:</i>	iTNC 530 / 5 840 D
<i>NC swivelling rotary tables:</i>	
<i>Table with torque:</i>	Ø 700 mm
<i>Swivelling range:</i>	+ 100° / - 130°
<i>A/C-axis speed:</i>	20/30 1/min
<i>Max. table load:</i>	2000 kg
<i>Table with torque:</i>	Ø 1150 x 900 mm
<i>Swivelling range:</i>	+ 100° / - 130°
<i>A/C-axis speed:</i>	20/30 1/min
<i>Max. table load:</i>	2000 kg



02.1

The machine . MT



Combines highly dynamic milling/turning simultaneously in up to 5 axes:
Thanks to the revolutionary MT design, all turning operations can be performed even with the table swivelled. The C 50 U MT machining centre can also process workpieces up to 2000 kg in weight.

www.hermle.de/c50/facts

TECHNICAL DATA

Traverse X-Y-Z: 1000 - 1100 - 750 mm

Speed: 12000 / 18000 rpm

Rapid linear traverses X-Y-Z: 60 - 60 - 55 m/min

Linear acceleration X-Y-Z: 6 m/s²

Control unit: TNC 640 / S 840 D

NC swivelling rotary table:

Table with torque: Ø 1000 mm

Swivelling range: + 100° / - 130°

A/C-axis speed: 20/500 1/min

Max. turning table load: 1000 kg

Max. milling table load: 2000 kg

- Fully integrated rotary technology
- Integrated balancing system
- Reinforced top
- Production booth
- Milling operations: 5-side machining/
up to 5 axes simultaneous machinings
- Turning operations: Horizontal/vertical turning,
up to 5 axes simultaneous machinings



02.2

A new dimension of dynamics



3 axes in the tool dynamics independent of workpiece

Pick-up magazine integrated into the base body to save space

Stainless steel lining of entire working area

Optimised chip ejection in working area during dry machining

Swivelling range of NC swivelling rotary table +100° to -130°

Large working area relative to the installation area

Accessibility, excellent ergonomics

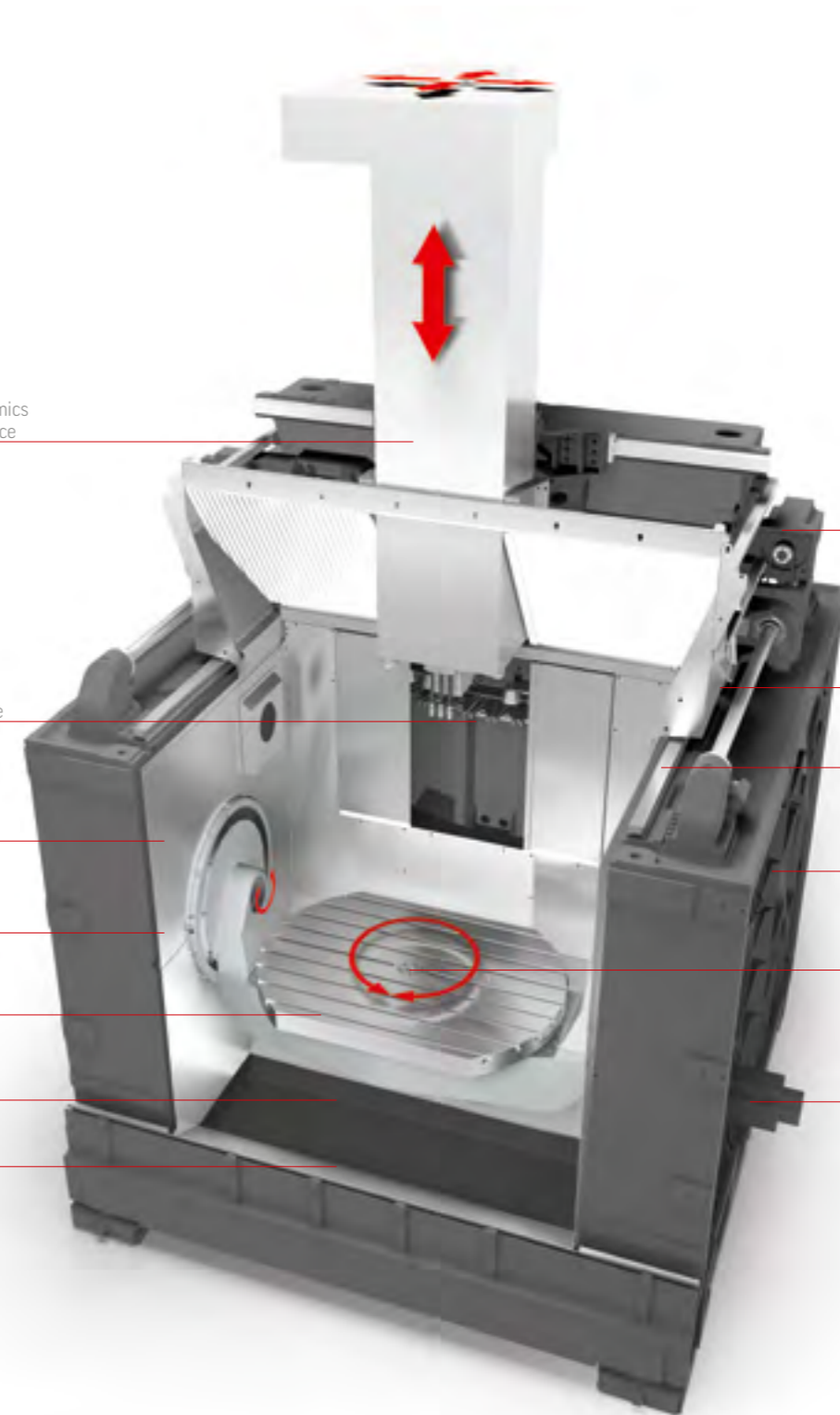

Tandem drive (Y axis) for high machine dynamics in the Y axis

Force characteristics: 3 guideways with one guide shoe for ideal force balance

Linear axes above the working area

Modified gantry design with optimum main axis support

Torque motor (C axis) for high dynamics

Tandem drive (A axis) Torsion avoidance and high level of accuracy

02.3

The workpiece

Many important points must be observed in order to guarantee that every workpiece is machined perfectly. For this reason, Hermle has been working on perfecting and optimising the machining process for many years. This is the reason that the C 50 is now equipped with:

- The largest working area relative to the installation area
- The largest swivelling range of workpieces in the working area
- Utilisation of the entire traverse range
- A large collision circle between the table flanges

www.hermle.de/c50/workpiece

THE WORKPIECE DIMENSION

- Unhindered crane loading from directly above the table centre
- When loading the crane the spindle moves to the magazine – this means the working area is completely clear and accessible
- Extensive automation solutions for optimum workpiece handling

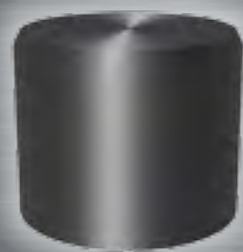

5-axis / MT

Ø 1000 x 810 mm

max. 2000 kg

MT: max. 1000 / 2000 kg

Collision circle: Ø 1310 mm



5-axis machining

02.4 Ergonomics

Built for daily use: the Hermle C 50 can be ergonomically adapted for every machine operator for optimum ease of use, simple operation and uncomplicated maintenance.

www.hermle.de/c50/ergonomics

HIGHLIGHTS

- Ergonomic control panel
 - Adjustable height +/- 100 mm
 - Tilting screen 0 - 30°
 - 19" screen
- Optimum loading height
- Laminated safety glass panes
- Automatic and reinforced cabin top
- Crane loading
- Minimum interval between table and operator
- Large door opening
- Additional control panel in area of tool loading station
- Lockable fluid box

Screen pivotable
by up to 30°

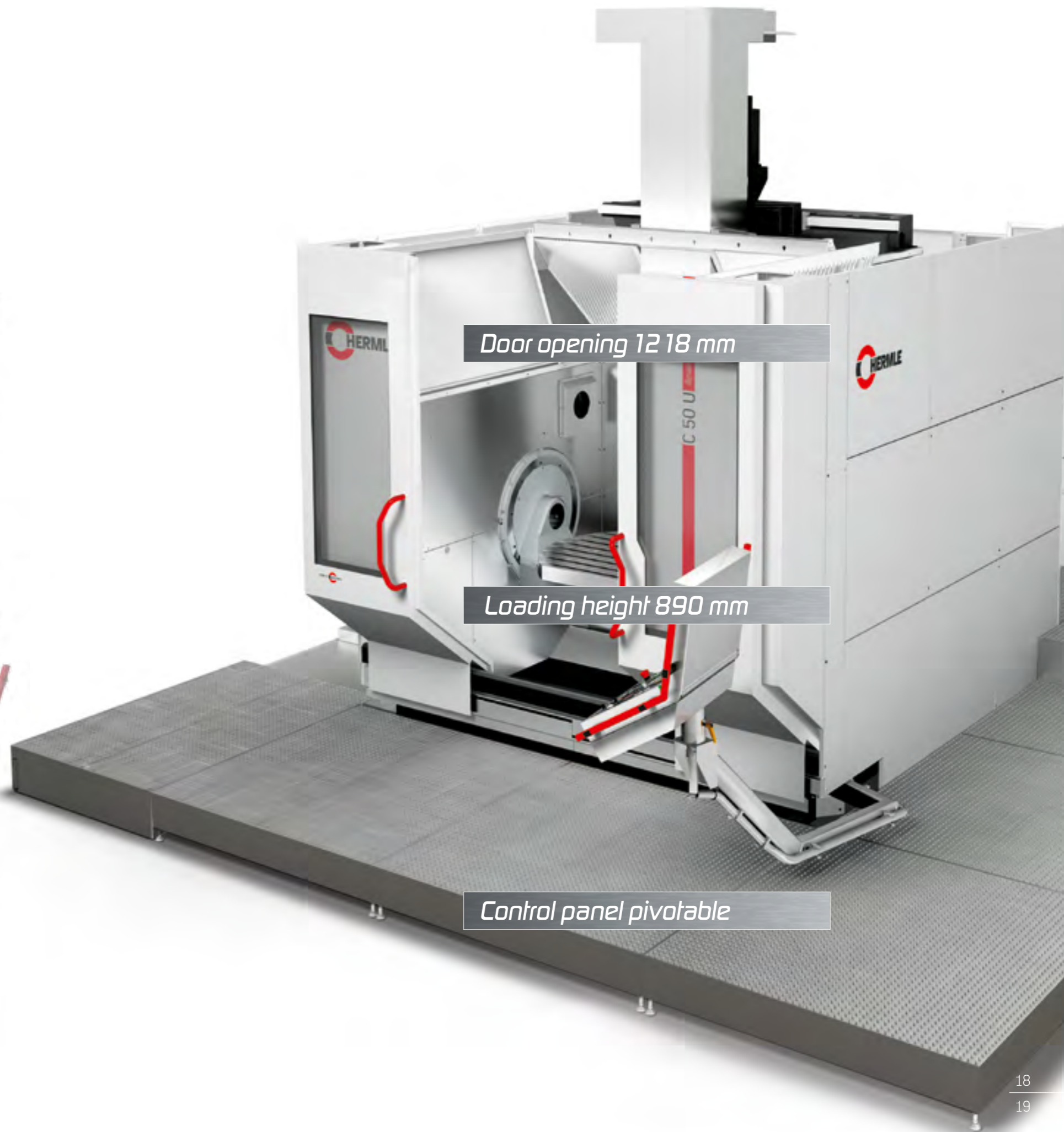
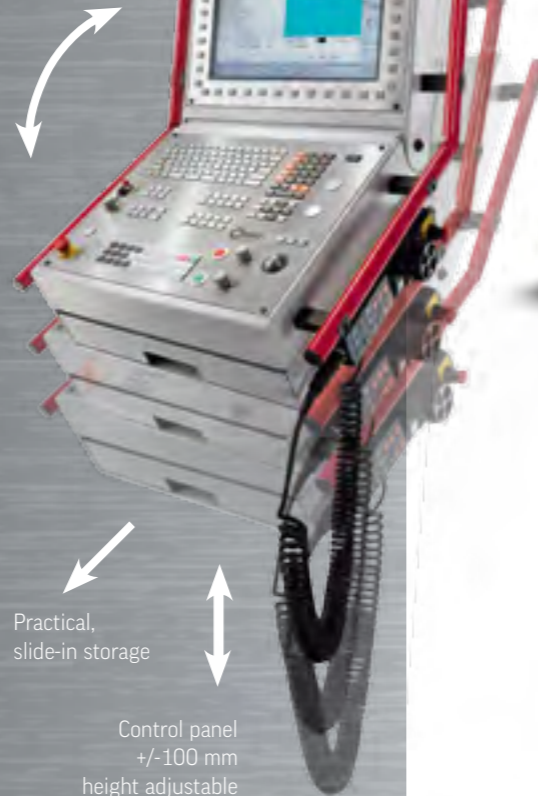

02.5 Table variants

Hermle's NC swivelling rotary table has revolutionised the concept of 5-axis machining. Also with the C 50, five axis operation is a key attribute, this capability is enhanced through the use of a torque drive. All tables are manufactured exclusively and entirely at our plant in Gosheim.

Uncompromised perfection: this tandem drive design accesses the gearwheel on the table housing directly and so completely eliminates shaft torsion. This is the only way to achieve the highest precision.

www.hermle.de/c50/tables



02.5 Table variants

Made in Germany – made in Gosheim: the C 50 table variants stand for the highest quality and optimum material usage from the cast housing to the installed torque motors. At our main plant in Gosheim, these tables are laying the foundations for the precision, accuracy and quality of the machined surfaces.



Hermle tables are equipped with cutting edge drive technology for high dynamic performance during 5 axis machining, as it is the slowest axis that determines the speed when milling in 5 axes. High-torque motors and the adapted gear can position loads of up to 2000 kg rapidly and, most importantly, with exceptional precision.

TECHNICAL DATA

High degree of freedom in working area

- Very high table load (up to 2000 kg with the highest accuracy)
- No accumulation of chip on the table (swivel table)
- Swivelling axis A and rotary axis C are located within the workpiece (U-shape)
- Torsion prevented by tandem drive
- Wide spacing between the A axis flanges results in very large collision circle
- High swivelling range for undercuts

Torque table

- High dynamics on the A and C axes
- Closed cooling jacket
- No wear
- Direct, absolute measuring system

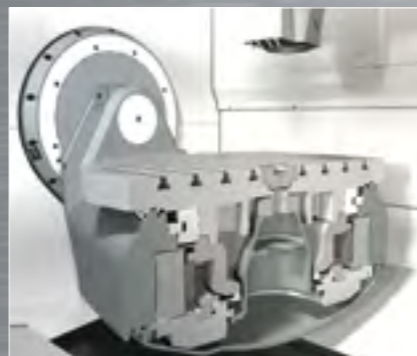

DRIVE TECHNOLOGY

- Central table load
- Drive directly on table housing = low torsion A axis
- Direct, absolute measuring system
- Good maintenance accessibility
- A axis integrated in machine bed

Tandem drive

- Mechanical tandem drive to left and right of table housing



NC swivelling rotary table

C-axis drive type: torque



The "Torque" NC swivelling rotary table provides the ideal conditions for highly dynamic 5-axis and simultaneous 5-axis machining.

www.hermle.de/c50/tables



Secondary clamping plates . 1200 x 700 mm



Zero-point clamping systems / pallet clamping systems

Clamping surface:	Ø 700
T grooves:	parallel 9 / 14 H7
Swivelling range:	+100° / -130°
C-axis drive type:	Torque
Speed - rotary axis C:	30 rpm
A-axis drive type:	mechanical tandem
Speed - swivelling axis A:	20 rpm
Max. table load:	2000 kg



Clamping surface:	Ø 1150 x 900
Table plate circle monitoring:	Ø 1310 mm
T grooves:	parallel 9 / 18 H7
Swivelling range:	+100° / -130°
C-axis drive type:	Torque
Speed - rotary axis C:	30 rpm
A-axis drive type:	mechanical tandem
Speed - swivelling axis A:	20 rpm
Max. table load:	2000 kg

NC swivelling rotary table . MT

C-axis drive type: torque



Zero-point clamping systems / pallet clamping systems

Clamping surface:	Ø 1000
T grooves:	star 16 / 18 H7
Swivelling range:	+100° / -130°
C-axis drive type:	Torque
Speed - rotary axis C:	500 rpm
A-axis drive type:	mechanical tandem
Speed - swivelling axis A:	20 rpm
Max. turning table load:	1000 kg
Max. milling table load:	2000 kg

02.6 Spindles



The C 50 is equipped with compact spindles. All spindles can be replaced quickly and easily in case of failure. The spindles are available in five different speed ranges and a choice of tooling platforms making them suitable for a wide variety of machining tasks. Like the tables, all spindles are manufactured exclusively and entirely at our plant in Gosheim.

www.herml.de/c50/spindles

TECHNICAL DATA

- High-tech spindles for demanding milling processes
- Slim-end spindle for machining deep cavities
- Few projecting edges (prevention of collision)

Spindle 12000 rpm . MT

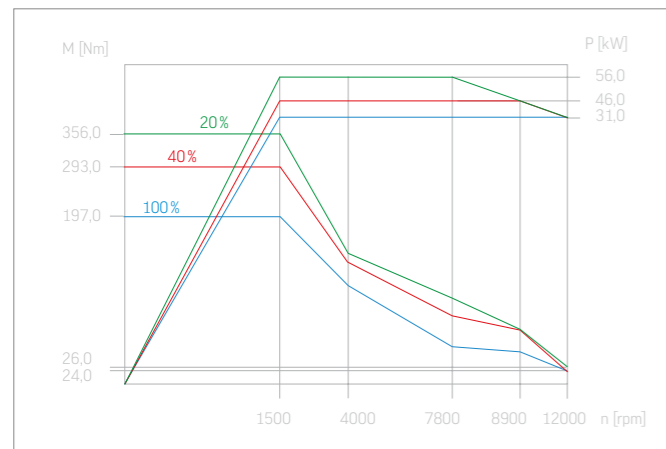

Maximum spindle speed: 12000 rpm
 Main Power 20% c.d.f.: 56 kW
 Torque 20% c.d.f.: 356 Nm
 Tool holding fixture: HSK T 100
 Spindle: compact



Spindle 18000 rpm . MT

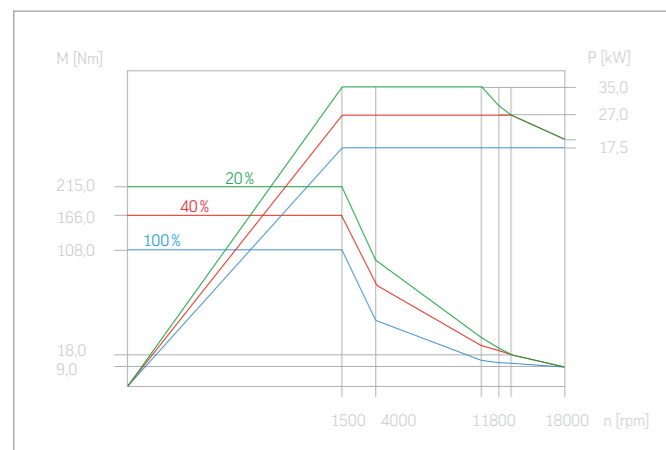

Maximum spindle speed: 18000 rpm
 Main Power 20% c.d.f.: 35 kW
 Torque 20% c.d.f.: 215 Nm
 Tool holding fixture: HSK T 63
 Spindle: compact



Spindle 9000 rpm

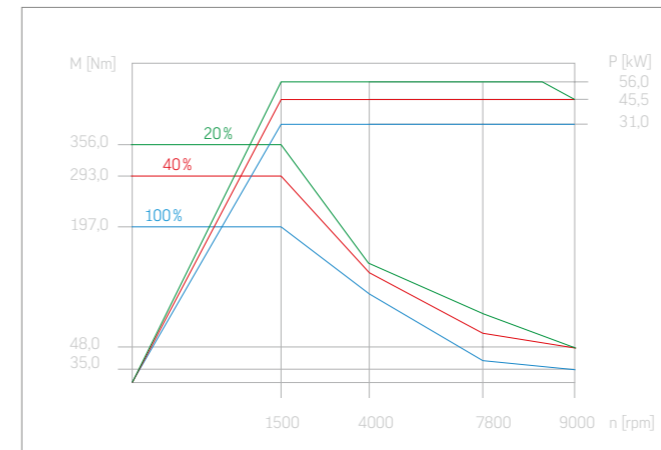

Maximum spindle speed: 9000 rpm
 Main Power 20% c.d.f.: 56 kW
 Torque 20% c.d.f.: 356 Nm
 Tool holding fixture: SK 50
 Spindle: compact

Spindle 9000 rpm

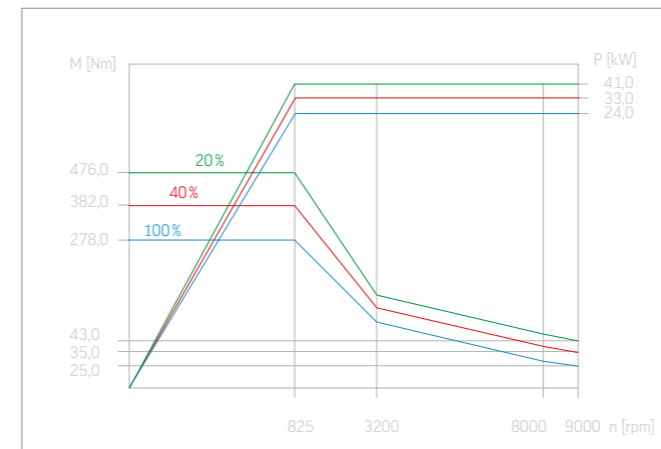

Maximum spindle speed: 9000 rpm
 Main Power 20% c.d.f.: 41 kW
 Torque 20% c.d.f.: 476 Nm
 Tool holding fixture: HSK A 100
 Spindle: compact

Spindle 10000 rpm

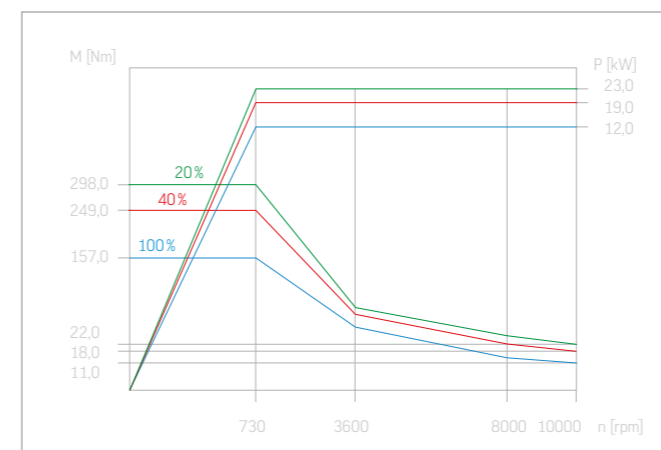

Maximum spindle speed: 10000 rpm
 Main Power 20% c.d.f.: 23 kW
 Torque 20% c.d.f.: 298 Nm
 Tool holding fixture: HSK A 63
 Spindle: compact

Spindle 12000 rpm

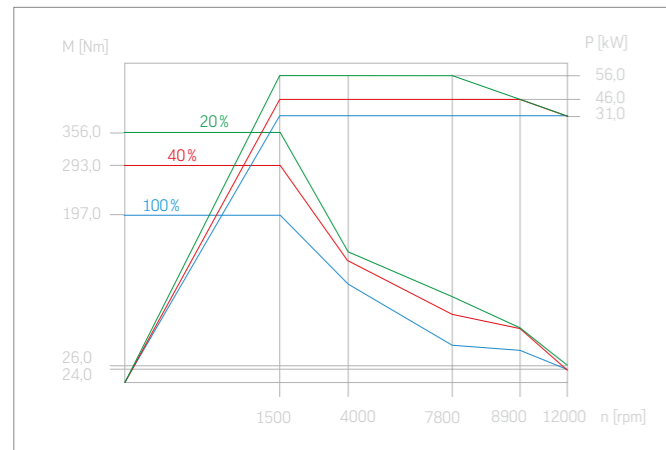

Maximum spindle speed: 12000 rpm
Main Power 20% c.d.f.: 56 kW
Torque 20% c.d.f.: 356 Nm
Tool holding fixture: HSK A 100
Spindle: compact

Spindle 15000 rpm

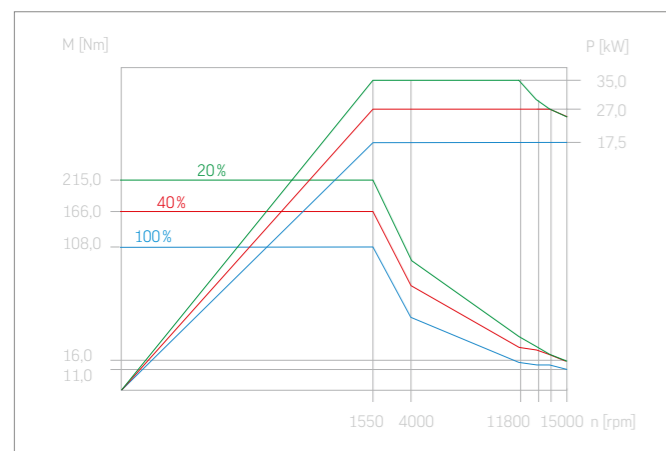

Maximum spindle speed: 15000 rpm
Main Power 20% c.d.f.: 35 kW
Torque 20% c.d.f.: 215 Nm
Tool holding fixture: SK 40
Spindle: compact

Spindle 18000 rpm

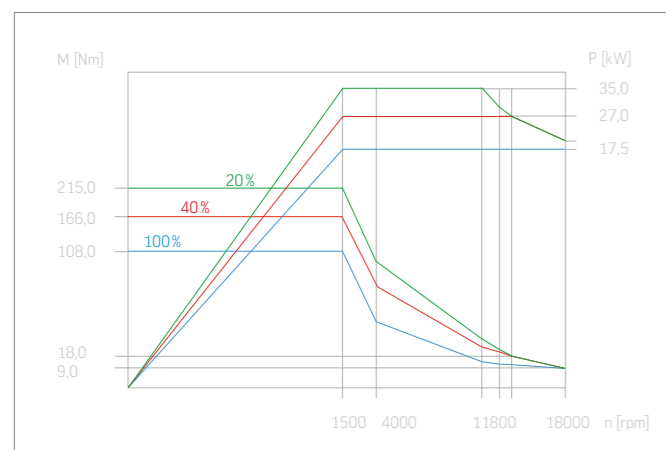

Maximum spindle speed: 18000 rpm
Main Power 20% c.d.f.: 35 kW
Torque 20% c.d.f.: 215 Nm
Tool holding fixture: HSK A 63
Spindle: compact



02.7

High-performance machining

The C 50 with the 12000 spindle is a machining miracle. 1822 cm³/min in alloyed heat-treated steel shows what this machining centre can do – and still at the highest levels of precision.

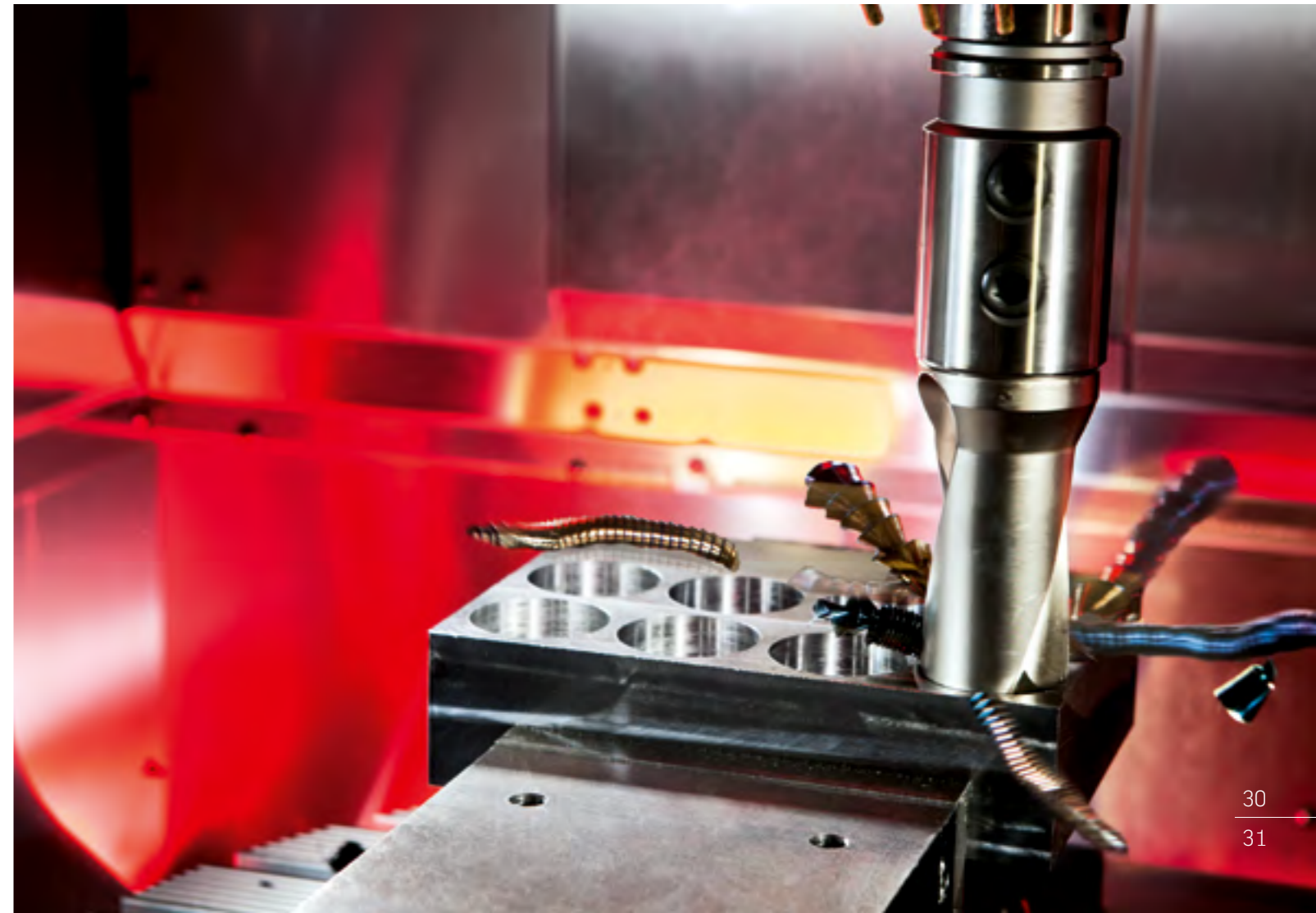

Main spindle

Speed:	12000 rpm
Torque:	356 Nm
Main power:	56 kW
Interface:	HSK A 100

Material

42CrMo4V (1.7225)
 Alloyed heat-treated steel for workpieces with higher stress resistance and larger tempering diameter.
 42CrMo4V is used for gear shafts, gear wheels, worms
 Tensile strength: 1000 – 1200 N/mm²
 [see CK 45 650 – 800 N/mm²]

Face milling

Material:	42CrMo4V
Tool:	face milling head D=100 mm with indexable inserts
Spindle speed:	1275 rpm
Vc:	400 m/min
Feed:	3440 mm/min
Fz:	0.27 mm
Depth of cut:	5.5 mm
Width of cut:	75.0 mm
Material removal rates:	1420 cm ³ /min

High-feed milling

Material:	42CrMo4V
Tool:	high-feed mill D=80 mm with indexable inserts
Spindle speed:	1500 rpm
Vc:	380 m/min
Feed:	20250 mm/min
Fz:	2.25 mm
Depth of cut:	1.5 mm
Width of cut:	60.0 mm
Material removal rates:	1822 cm ³ /min

Solid drilling

Material:	42CrMo4V
Tool:	solid drill D=70 mm with indexable inserts
Spindle speed:	1500 rpm
Vc:	330 m/min
Feed:	405 mm/min
Vu:	0.27 mm
Material removal rates:	1558 cm ³ /min

02.8

The magazine

The C 50's tool magazine holds up to 60 tools in the standard version and is integrated into the machine bed to save space. On the rear of the machine is the ground-level tool loading point with operator control panel. The adapted platform enhances ergonomics with easy accessibility.

www.hermle.de/c50/magazine

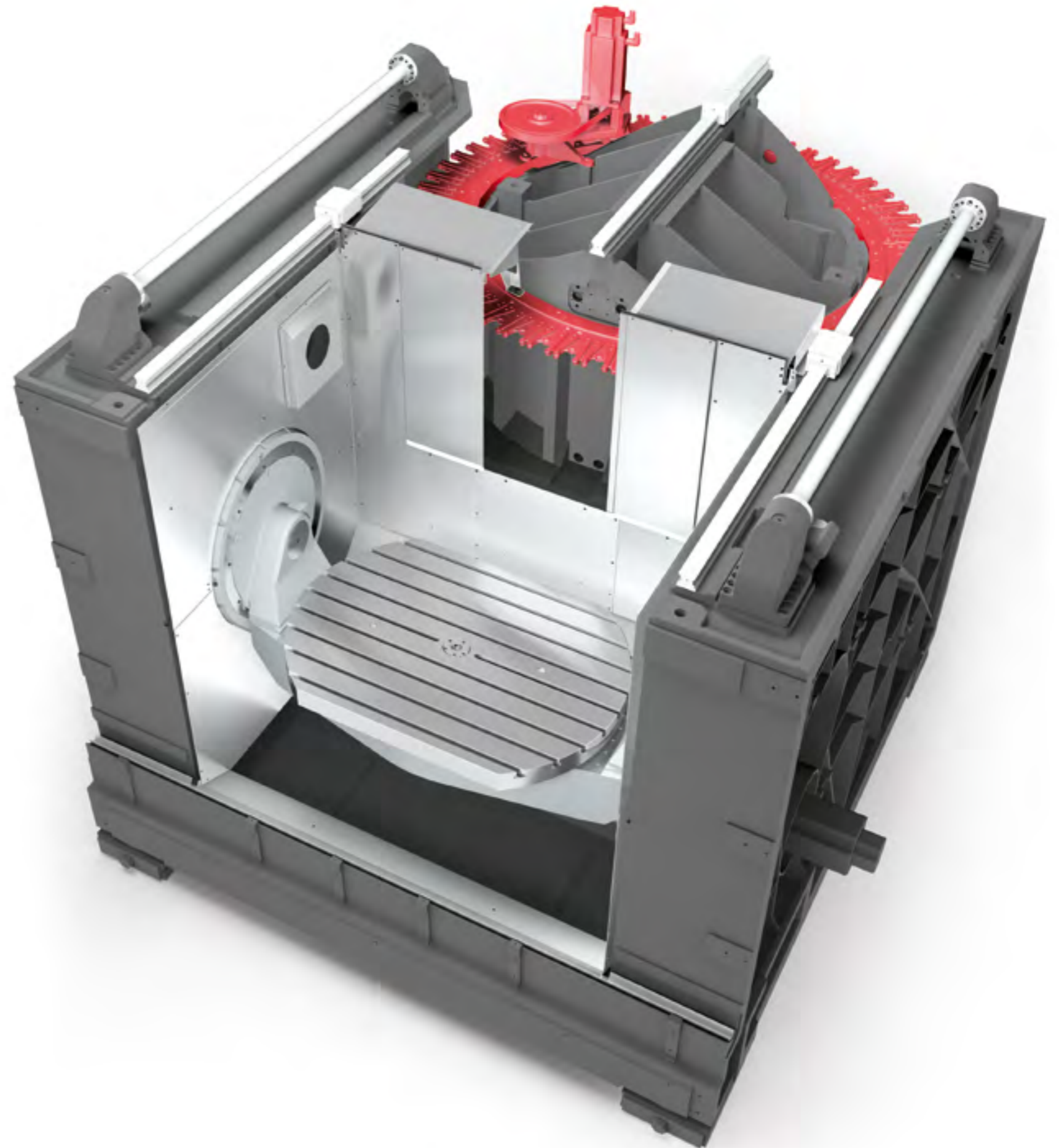

TECHNICAL DATA

Pick-up magazine

Integration into the machine bed

Excellent accessibility

Additional control panel next to tool loading point

Covers for tool holding fixture

Ergonomically optimum platform for the machine operator

Tool changer (pick-up)

Interface:	SK 40 / HSK A 63	SK 50 / HSK A 100
Interface MT:	HSK T 63	HSK T 100
Magazine pockets:	60	42
Max. tool weight:	15 kg	30 kg
Max. tool diameter:	Ø 160 mm	Ø 250 mm
Max. tool length:	430 mm	430 mm
Max. magazine load:	480 kg	462 kg
Chip-to-chip time*:	7.0 s	7.0 s

*[chip-to-chip times for 3-axis units in milling mode calculated in keeping with German standard VDI 2852, page 1]

Additional magazine ZM 41



Magazine pockets: 41
Tool holding fixtures: SK 40/HSK A 63/
HSK T 63
Max. tool weight: 15 kg
Max. tool diameter: Ø 80, with empty
adjacent pockets
Ø 160 mm
Max. tool length: 430 mm

Additional magazine ZM 42



Magazine pockets: 42
Tool holding fixtures: SK 50/HSK A 100/
HSK T 100
Max. tool weight: 30 kg
Max. tool diameter: Ø 80, with empty
adjacent pockets
Ø 250 mm
Max. tool length: 430 mm

Additional magazine ZM 124



Magazine pockets: 124
Tool holding fixtures: SK 50/HSK A 100/
HSK T 100
Max. tool weight: 30 kg
Max. tool diameter: Ø 80, with empty
adjacent pockets
Ø 250 mm
Max. tool length: 430 mm

Additional magazine ZM 162



Magazine pockets: 162
Tool holding fixtures: SK 40/HSK A 63/
HSK T 63
Max. tool weight: 15 kg
Max. tool diameter: Ø 80, with empty
adjacent pockets
Ø 160 mm
Max. tool length: 430 mm

Up to 8 tools can be loaded simultaneously



02.9 Control unit

The C 50 can be equipped with three types of control unit. All control units provide diverse program functions. Hermle simplifies programming and operation still further with comprehensive extra features.

www.hermle.de/control

Heidenhain

Milling and turning using one control unit

Heidenhain TNC 640

- The TNC 640 comes with all the functions of the iTNC 530
- Further special turning cycles are integrated such as roughing, finishing, grooving and threading
- Easy to switch from milling to turning mode

Heidenhain iTNC 530

- 19" TFT colour flat screen
- Keyboard unit with full keyboard, integrated trackball, USB and Ethernet interfaces
- Programming in Heidenhain plain text with smarT.NC or per DIN/ISO
- Standard drilling and milling cycles
- Touch probe system cycles
- Free contour programming
- Special functions for fast 3D machining
- Automatic calculation of cutting data
- Pallet management
- Software option Kinematic Opt
- Measurement cycle for improving accuracy of rotational and swivelling operations



For further advantages and detailed technical data, please see the Heidenhain brochures.

Siemens

Milling and turning using one control unit

Siemens S 840 D

- 19" TFT colour flat screen
- Keyboard unit with full keyboard, additional panel with integrated trackball, key-operated switch and buttons, USB and Ethernet interfaces
- Complete and flexible diagnostics and service concept
- Including shell transformation, 5-axis transformation and process-oriented measuring
- Incl. software option Kinematic Opt
- Measurement cycle for improving accuracy of rotational and swivelling operations
- Tool management for all machines HTDI
- The S 840 D is also equipped for turning mode and can handle all integrated milling and turning processes



For further advantages and detailed technical data, please see the Siemens brochures.



02.9 Control unit

Hermle control tools



Hermle tool management control
Simple, Hermle tool management for Heidenhain controls.



Hermle adaptive feed control
In adaptive feed control (AFC), the feed rate is automatically controlled (depending on the percentage of spindle output).



Hermle tool data information
Simple, Hermle tool management for the Siemens S 840 D sl.



Hermle wear diagnosis system
Machine status is continually monitored by the Hermle wear diagnosis system. It facilitates rapid machine diagnostics and status-oriented detection of maintenance tasks.



Hermle pallet management control
Simple, Hermle pallet management software for all automated manufacturing cells.

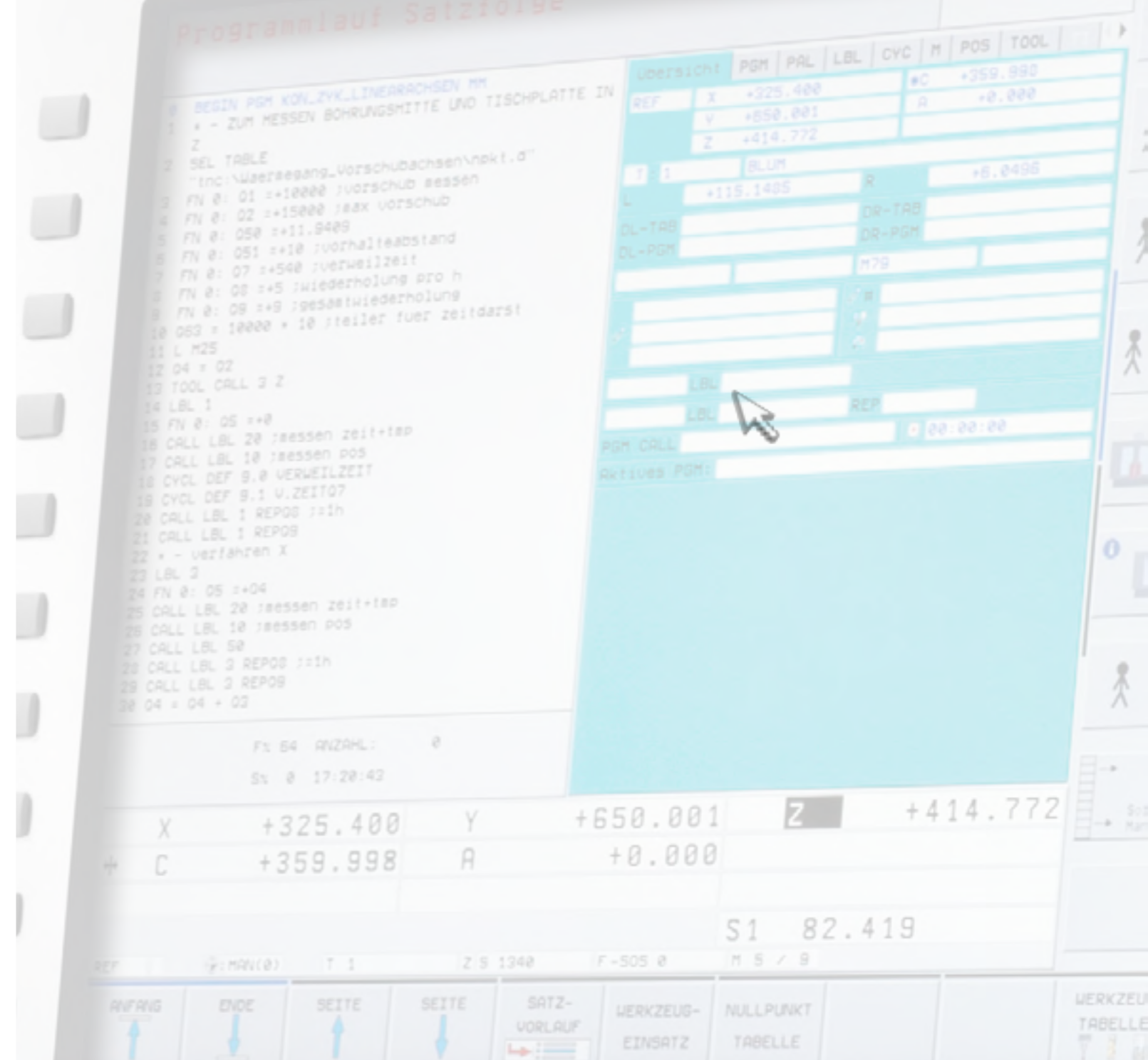

Hermle setups

Standard

Standard

- Standard setting.
- Switches back to the standard setting after a different setup has been used.

Heavy duty machining

Heavy duty machining

- For roughing in conjunction with high milling power.
- Greater machining performance possible thanks to reduced machine vibration (depending on the tool and the selected technology data).

High production

Production

- Quicker machining with programs which have many cycle calls or sub-programs.

3D contour tolerance max.

3D contour tolerance max.

- For 3D roughing with low machining performance.
- Very high machining speed, mainly for free-form surfaces.

3D contour tolerance min.

3D contour tolerance min.

- For very high demands of machining accuracy, mainly for free-form surfaces.
- Can also be used with conventional programs.

3D path smoothing

3D path smoothing

- For very high demands on the surface quality, mainly for free-form surfaces.



02.10 The details

The C 50's details are packed with know-how. All attachments and controls of the C 50 have been smartly optimised for users and designed specifically for respective machining tasks.

www.hermle.de/details



Central fluid box with doors on rear of machine



Cassette panel construction for quick and easy maintenance and servicing



02.10

The details

The C 50 is built using an elegant cassette panel construction. This high-tech building block concept is used throughout from the standard machine to the flexible manufacturing system. The machining centre can be transported without any disassembly and set up without a foundation. Furthermore, all units are arranged for easy maintenance and servicing.

www.hermle.de/details

HIGHLIGHTS

Comprehensive fluid technology

Optimised chip management

Diverse coolant equipment

We provide the correct method of chip removal from the working area for all kinds of chip



Space-saving chip conveyor arrangement



Chip conveyor



Chip conveyor with internal coolant supply



Chip conveyor with recooling unit and internal coolant supply



Chip conveyor with recooling unit, internal coolant supply and emulsion mist extraction

03

Technical data . C 50

www.hermle.de/c50



03.1

Technical data . C 50

Working area			
Traverse	X axis	1000 mm	
Traverse	Y axis	1100 mm	
Traverse	Z axis	750 mm	
Rapid linear traverses	X-Y-Z	60-60-55 m/min	
Linear acceleration	X-Y-Z	6 m/s ²	
Linear feed force	X-Y-Z	16000 N	
Width across flats		950 mm	
Max. workpiece diameter		Ø 1000 mm	
Max. workpiece height		810 mm	
Main spindle drive			
Speed	9000 rpm	SK 50	○
Main power/Torque	20% c.d.f.	56 kW / 356 Nm	
Speed	9000 rpm	HSK A 100	○
Main power/Torque	20% c.d.f.	41 kW / 476 Nm	
Speed	10000 rpm	HSK A 63	○
Main power/Torque	20% c.d.f.	23 kW / 298 Nm	
Speed	12000 rpm	HSK A 100	○
Main power/Torque	20% c.d.f.	56 kW / 356 Nm	
Speed	15000 rpm	SK 40	●
Main power/Torque	20% c.d.f.	35 kW / 215 Nm	
Speed	18000 rpm	HSK A 63	○
Main power/Torque	20% c.d.f.	35 kW / 215 Nm	
Speed (MT variants)	12000 rpm	HSK A 100 / HSK T 100	
Main power/Torque	20% c.d.f.	56 kW / 356 Nm	
Speed (MT variants)	18000 rpm	HSK A 63 / HSK T 63	
Main power/Torque	20% c.d.f.	35 kW / 215 Nm	
Control unit			
Heidenhain		iTNC 530	●
Heidenhain (with MT variant)		TNC 640	
Siemens (also for MT variant)		Sinumerik 840 D	○

Tool changer (pick-up)			
Interface	SK 40 / HSK A 63 / HSK T 63	SK 50 / HSK A 100 / HSK T 100 ○	
Magazine pockets	60	42	
Chip-to-chip time*	approx. 7.0 s	approx. 7.0 s	
*(chip-to-chip times for 3-axis units in milling mode calculated in keeping with German standard VDI 2852, page 1)			
Max. tool length	430 mm	430 mm	
Max. tool diameter	Ø 160 mm	Ø 250 mm	
Max. magazine load	480 kg	462 kg	
Extension of tool storage capacity			
Additional magazine with additional		41 / 42 / 124 / 162 pockets ○	
Max. tool diameter in the additional magazine		Ø 160 / Ø 250 mm	
Max. tool diameter with corresponding adjacent pocket allocation in additional magazine		Ø 250 mm / Ø 250 mm	
Max. tool weight		15 / 30 kg	
Table variants*			
NC swivelling rotary table	Ø 700	Ø 1150	Ø 1000 (MT variant)
Clamping surface	Ø 700 mm	Ø 1150 mm	Ø 1000 mm
Clamping surface flattened on 2 sides	-	900 mm	-
Swivelling range	+100° / -130°	+100° / -130°	+100° / -130°
C-axis drive mode	torque	torque	torque
Speed - swivelling axis A	20 rpm	20 rpm	20 rpm
Speed - rotary axis C	30 rpm	30 rpm	500 rpm
Max. milling table load	2000 kg	2000 kg	2000 kg
Max. turning table load	-	-	1000 kg
T grooves parallel	9 units / 14 H7	9 units / 18 H7	-
T grooves star			16 units / 18 H7

● Included in standard delivery
○ Available upon request

*All tables available on demand

Position measuring system, direct	Resolution	0.0001 mm ●
Positional tolerance	Tp in X-Y-Z axes according to VDI/DGQ 3441 (calculated at a constant ambient temperature of 20 °C +/-1 °C. Our products are subject to the German Export Law and require authorization since the attainable precision may be less/greater than 6 µm.)	0.008 mm ●
Chip conveyor	Scraper belt conveyor	●
	Hinged belt conveyor	
	Chip conveyor ejection height	1100 mm
	Chip cart	450 l ○
Coolant equipment	Amount of coolant	500 l ●
	Pump capacity	5 bar / 80 l/min
Internal coolant supply with paper band filter	Amount of coolant	1500 l
	Pressure (manually adjustable up to)	max. 80 bar / 26 l/min
	Mains connection (ICS)	400 V / 50 Hz
	Power consumption (ICS)	18.5 kVA
Hydraulics	Operating pressure	120 bar ●
Central lubrication	Minimum grease lubrication quantity	●
Weight	(standard version without optional extras, attachments, workpieces and coolant)	Approx. 21.0 t
Connected loads	Mains connection	400 V / 50 Hz
	Power consumption	71 / 84 kVA
	Compressed air	6 bar

- Included in standard delivery
○ Available upon request

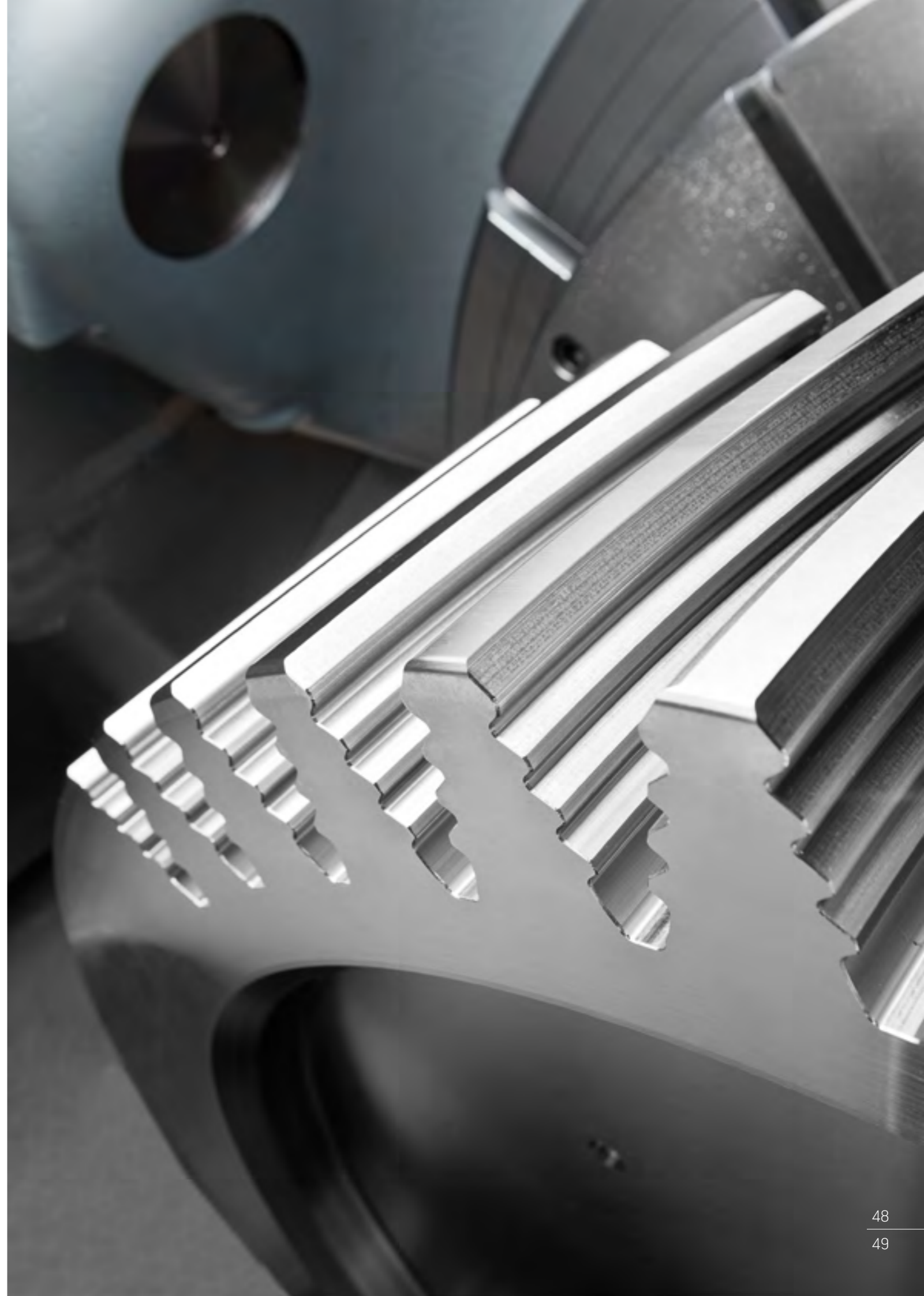

03.2 Options

The C 50 is prepared for anything: Numerous optional extras make machining even more efficient and powerful in real applications and enable you to optimise your work with the machining centre still further.

www.herml.de/options

C 50 U dimensions

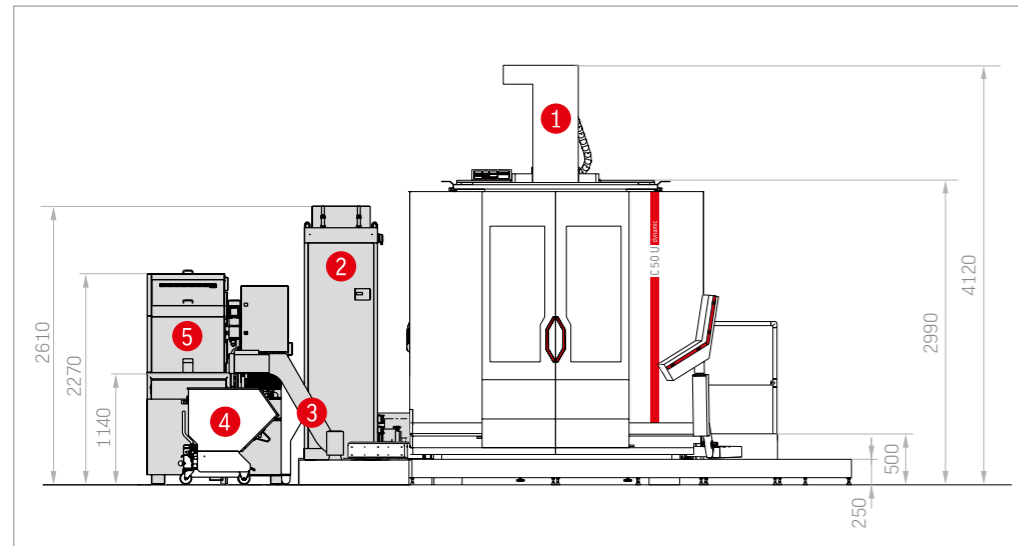

- 1 Machine
- 2 Emulsion mist extraction
- 3 Chip conveyor
- 4 Chip cart
- 5 Internal coolant supply
- 6 Recooling unit

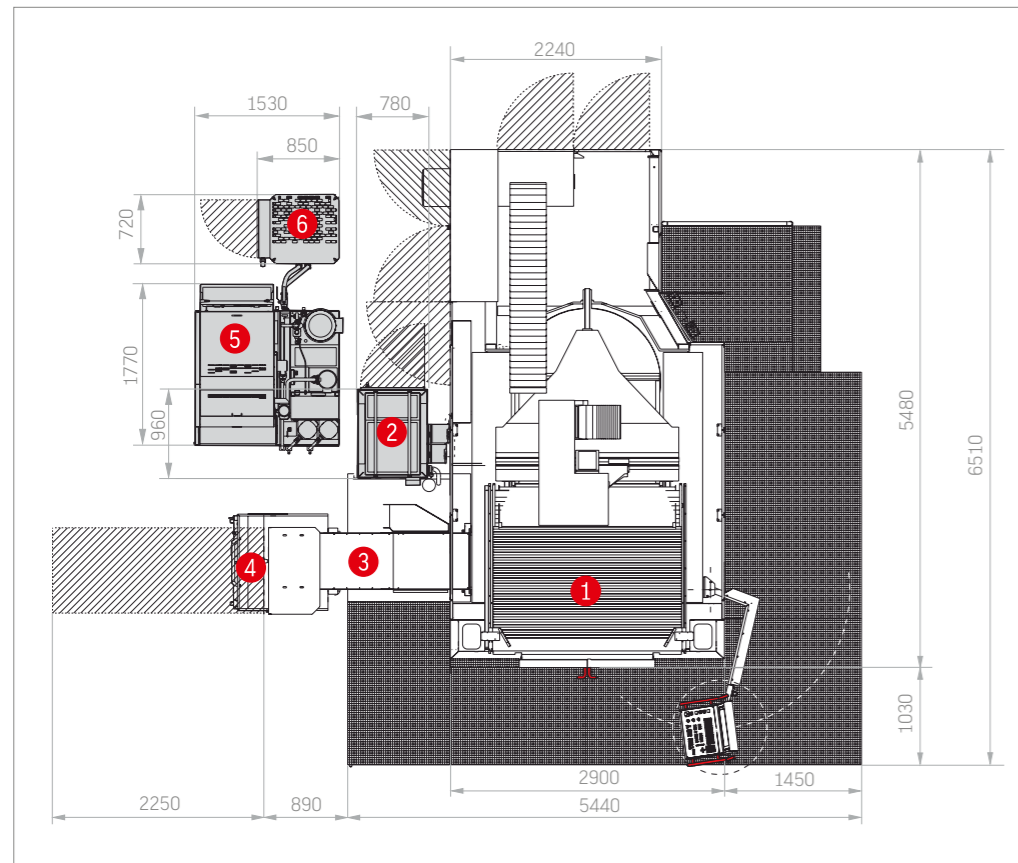

Options

- Automatic cabin door
- Rotating transparent window
- Control panel height adjustable with 19" swivel screen
- Elec. heat compensation
- Elec. hand-held control module
- Touch probe incl. preparation
- Preparation button
- Tool breakage monitoring/ measurement
- Coolant nozzle
- Minimum quantity lubrication external
- Rotary feedthrough
- Blow air through spindle centre
- Bed flushing
- BDE signal
- Emulsion mist extraction
- Air purge for linear scales
- Status lamp
- Additional magazines ZM 41/42/124/162
- Pallet changer
- Pallet storage

C 50 U MT dimensions

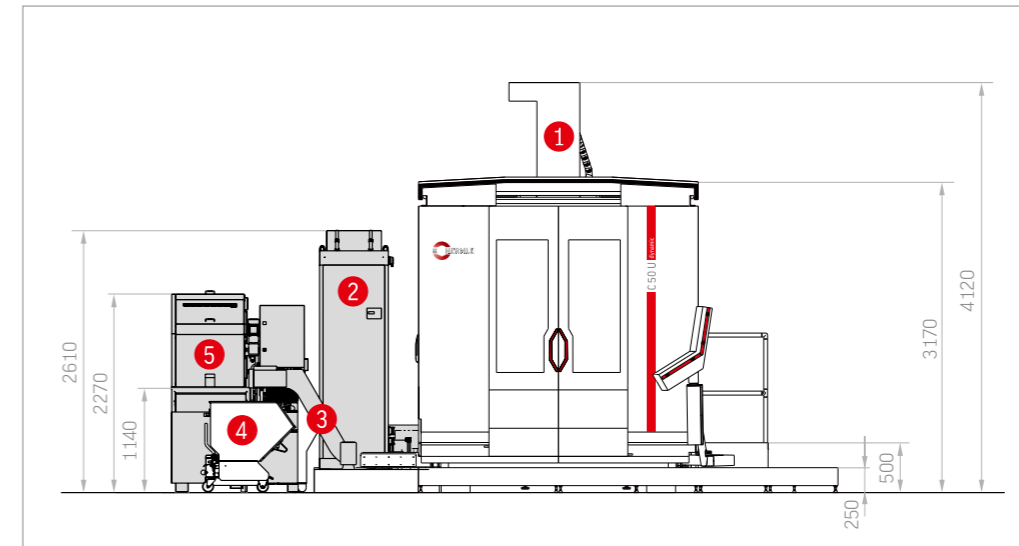

- 1 Machine
- 2 Emulsion mist extraction
- 3 Chip conveyor
- 4 Chip cart
- 5 Internal coolant supply
- 6 Recooling unit

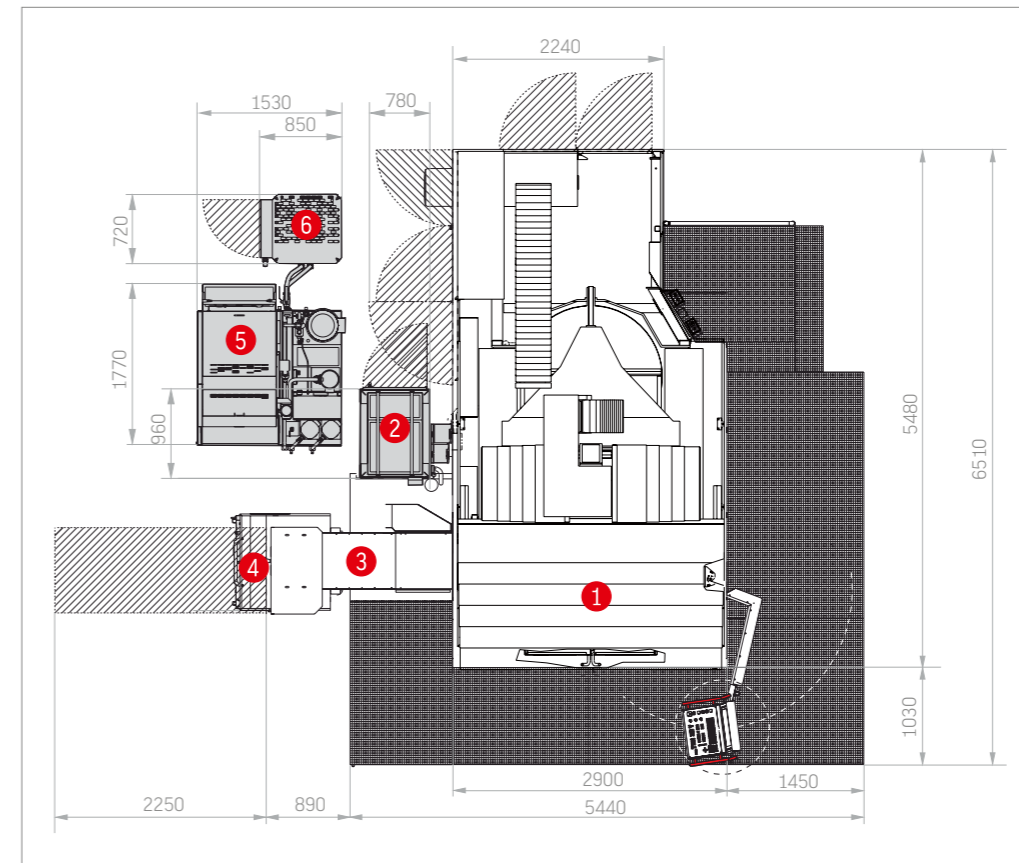

Options

- Automatic cabin door
- Rotating transparent window
- Control panel height adjustable with 19" swivel screen
- Elec. heat compensation
- Elec. hand-held control module
- Touch probe incl. preparation
- Preparation button
- Tool breakage monitoring/ measurement
- Coolant nozzle
- Minimum quantity lubrication external
- Rotary feedthrough
- Blow air through spindle centre
- Bed flushing
- BDE signal
- Emulsion mist extraction
- Air purge for linear scales
- Status lamp
- Additional magazines ZM 41/42/124/162
- Pallet changer
- Pallet storage

C 50 U dimensions . Additional magazine ZM 41

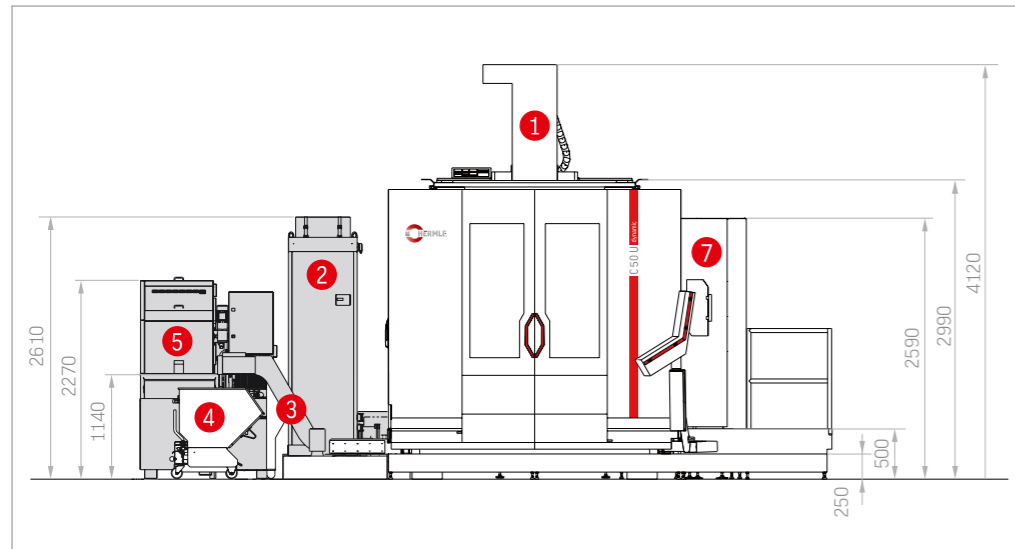

- 1 Machine
- 2 Emulsion mist extraction
- 3 Chip conveyor
- 4 Chip cart
- 5 Internal coolant supply
- 6 Recooling unit
- 7 Additional magazine ZM 41

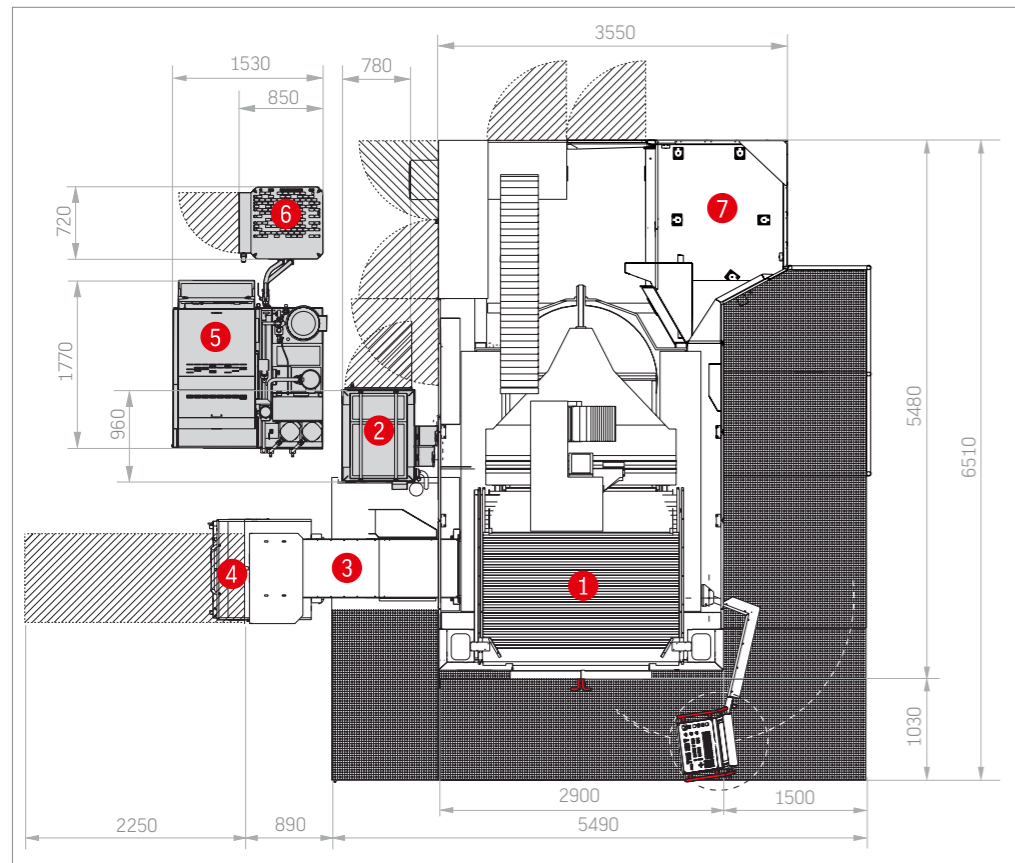

C 50 U dimensions . Additional magazine ZM 42

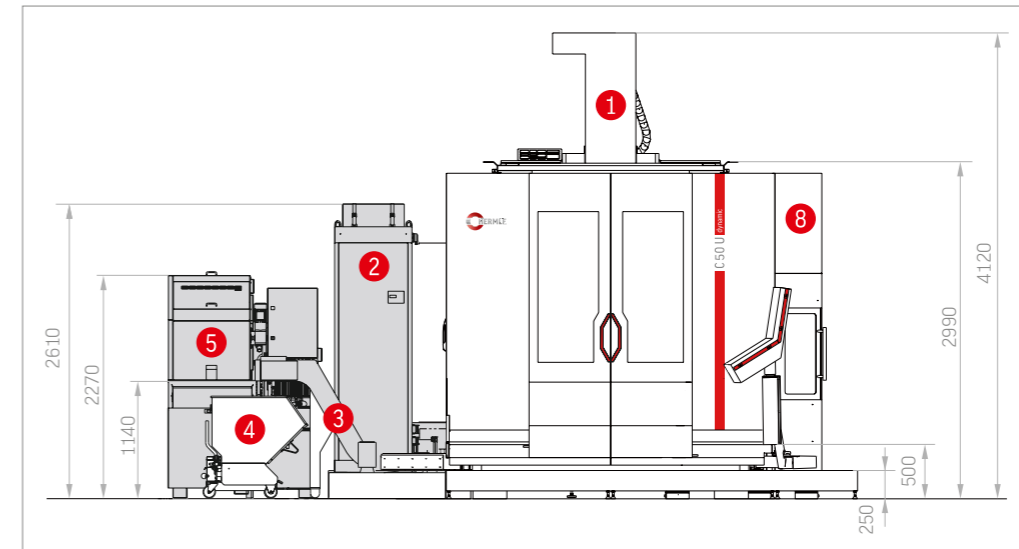

- 1 Machine
- 2 Emulsion mist extraction
- 3 Chip conveyor
- 4 Chip cart
- 5 Internal coolant supply
- 6 Recooling unit
- 8 Additional magazine ZM 42

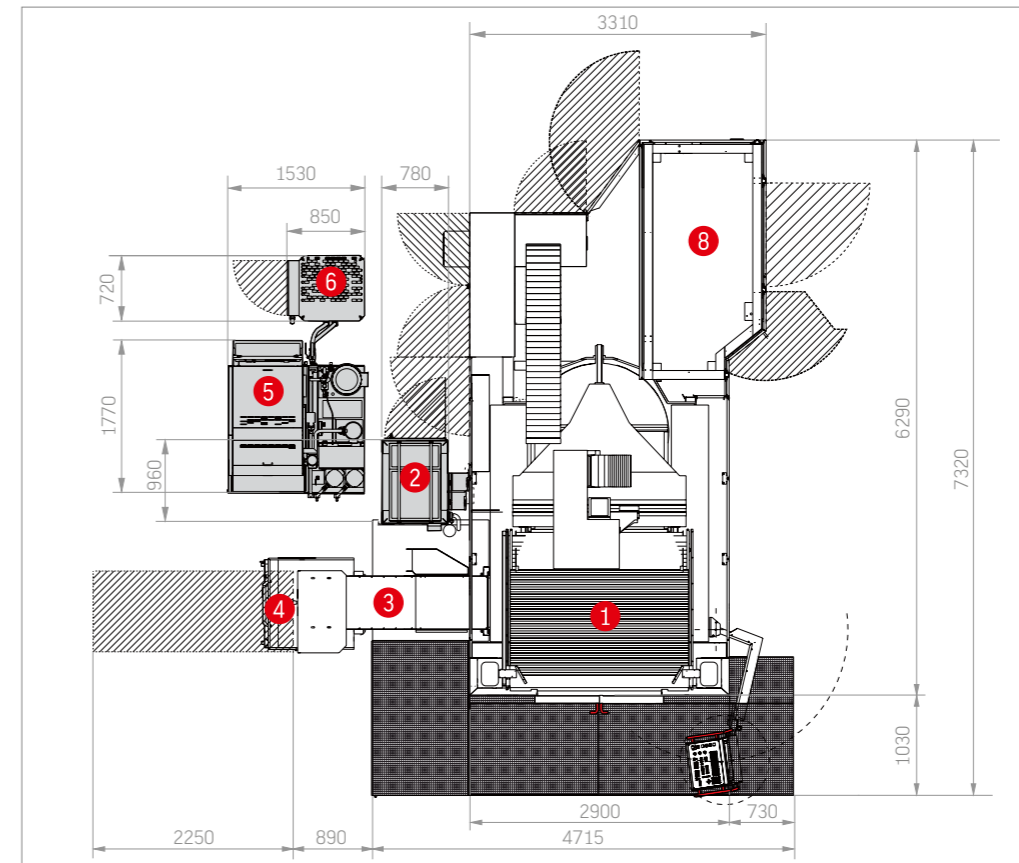

Options

- Automatic cabin door
- Rotating transparent window
- Control panel height adjustable with 19" swivel screen
- Elec. heat compensation
- Elec. hand-held control module
- Touch probe incl. preparation
- Preparation button
- Tool breakage monitoring/ measurement
- Coolant nozzle
- Minimum quantity lubrication external
- Rotary feedthrough
- Blow air through spindle centre
- Bed flushing
- BDE signal
- Emulsion mist extraction
- Air purge for linear scales
- Status lamp
- Additional magazines ZM 41/42/124/162
- Pallet changer
- Pallet storage

C 50 UP dimensions . Additional magazine ZM 124

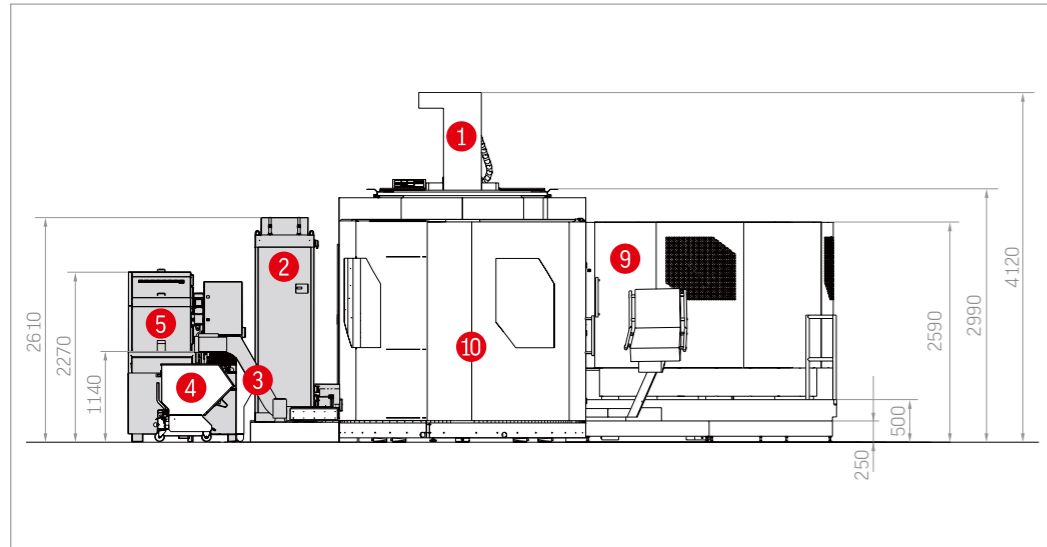

- 1 Machine
- 2 Emulsion mist extraction
- 3 Chip conveyor
- 4 Chip cart
- 5 Internal coolant supply
- 6 Recooling unit
- 9 Additional magazine ZM 124
- 10 Pallet changer PW 2000

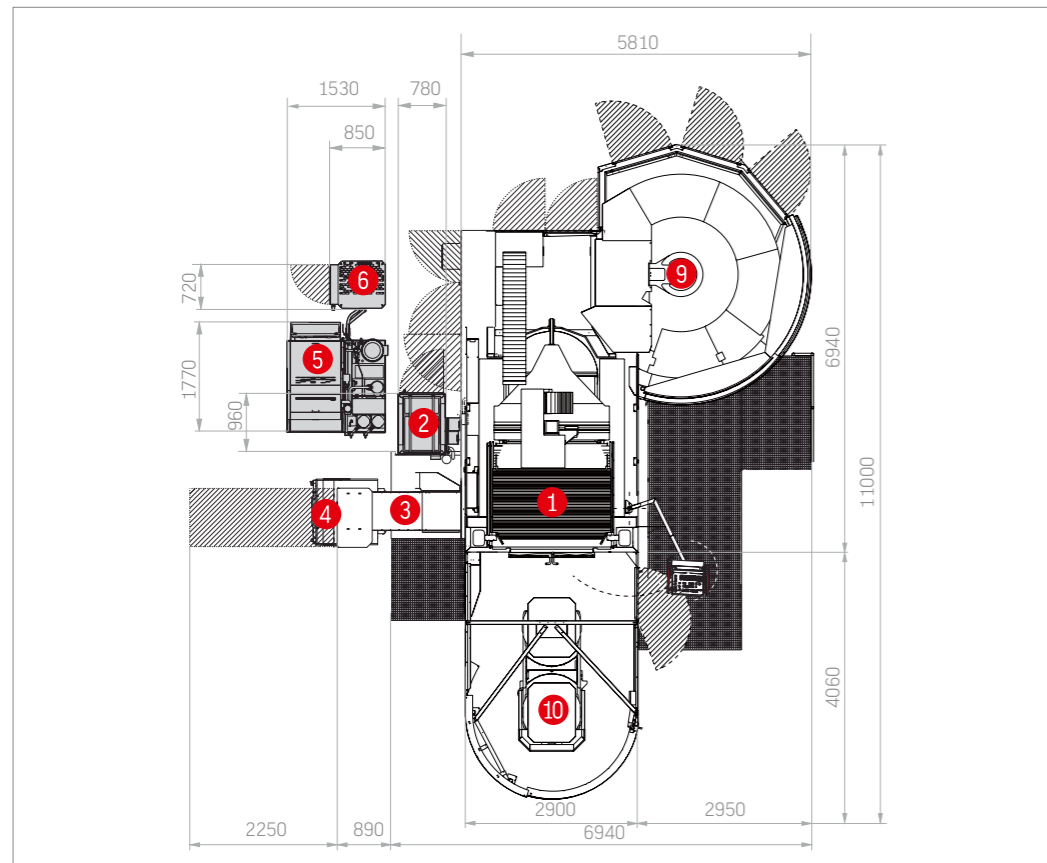

C 50 U dimensions. Additional magazine ZM 162

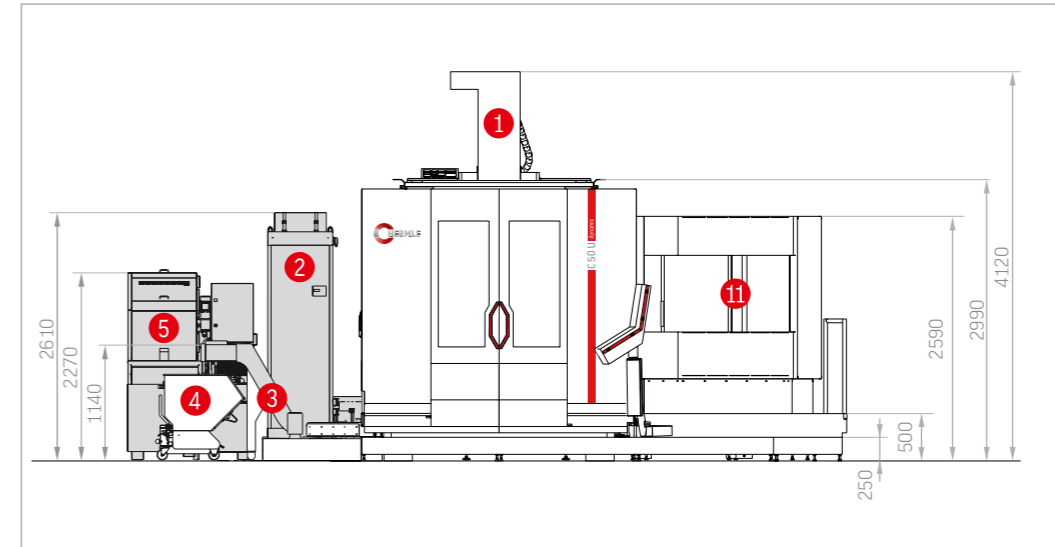

- 1 Machine
- 2 Emulsion mist extraction
- 3 Chip conveyor
- 4 Chip cart
- 5 Internal coolant supply
- 6 Recooling unit
- 11 Additional magazine ZM 162

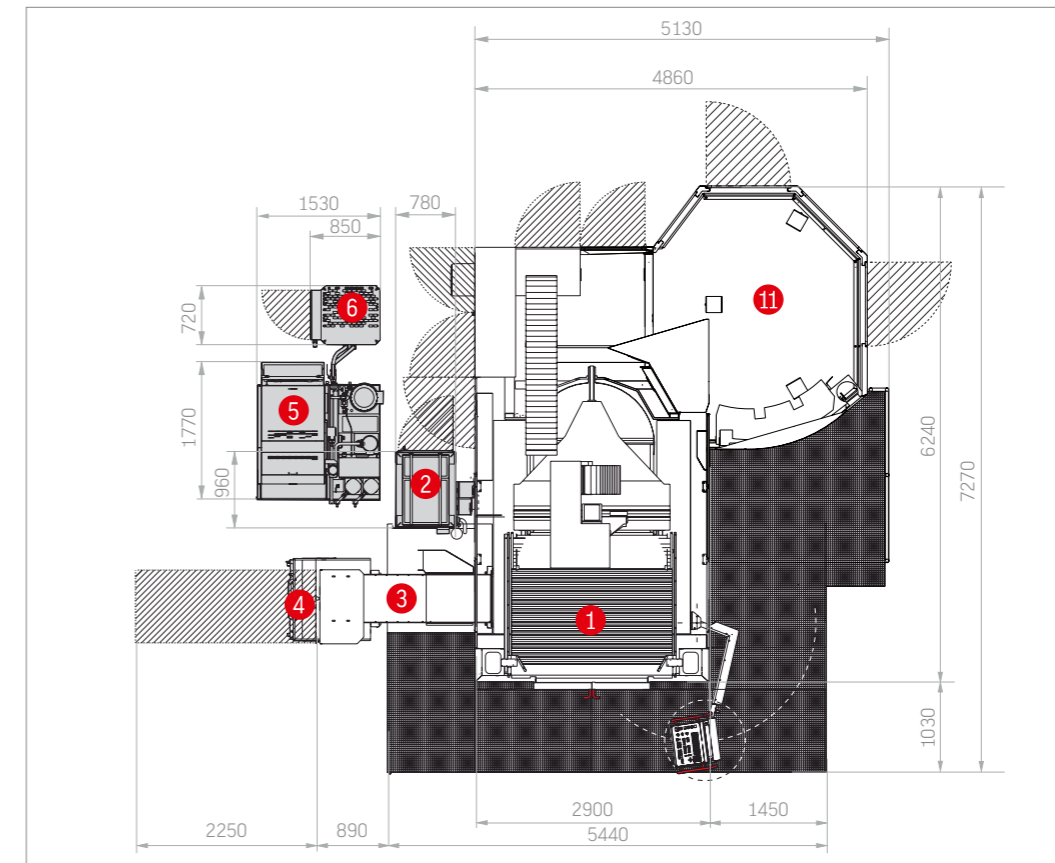

04 Automation



www.hermle.de/automation

04.1 Automation . C 50

Our pallet changer is setting new standards for parallel setup in our highly dynamic machining centres. A further increase in productivity allows for more adaptable storage systems. Machining centres can be set up via pallet storage for production-oriented machine runs with minimum operator interference/without operator interference or for customer-specific runs using a wide range of parts. Furthermore, multiple machining centres can be linked to form a complete manufacturing system.

www.hermle.de/automation



TECHNICAL DATA

<i>Pallet dimensions:</i>	800 x 800 / Ø 1000 mm 1000 x 800 / Ø 1166 mm
<i>Number of pallets without storage:</i>	2 pallets
<i>Number of pallets with storage:</i>	21 pallets
<i>Transport weight per side including pallet:</i>	max. 2000 kg
<i>Repeating accuracy:</i>	< 0,01 mm



Setup station is optimally accessible, including for crane loading.



Side access to the working area of the C 50 U for manual operations or in setup mode.



The PW 2000 can move up to 2000 kg including pallet from the setup station to the working area of the C 50 U.



04.1 Automation . C 50



Pallet changer PW 3000 with one 2/4-pallet storage module and setup station module, right



Pallet changer PW 3000 with two 2/4-pallet storage modules and setup station module, right

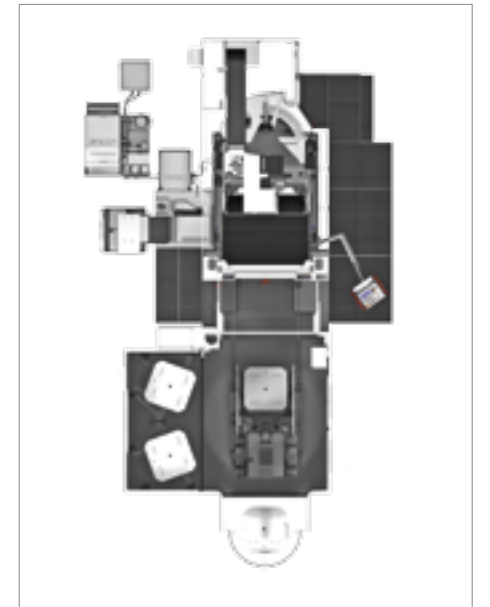

Pallet changer PW 3000 with one 2/4-pallet storage module and setup station module, front

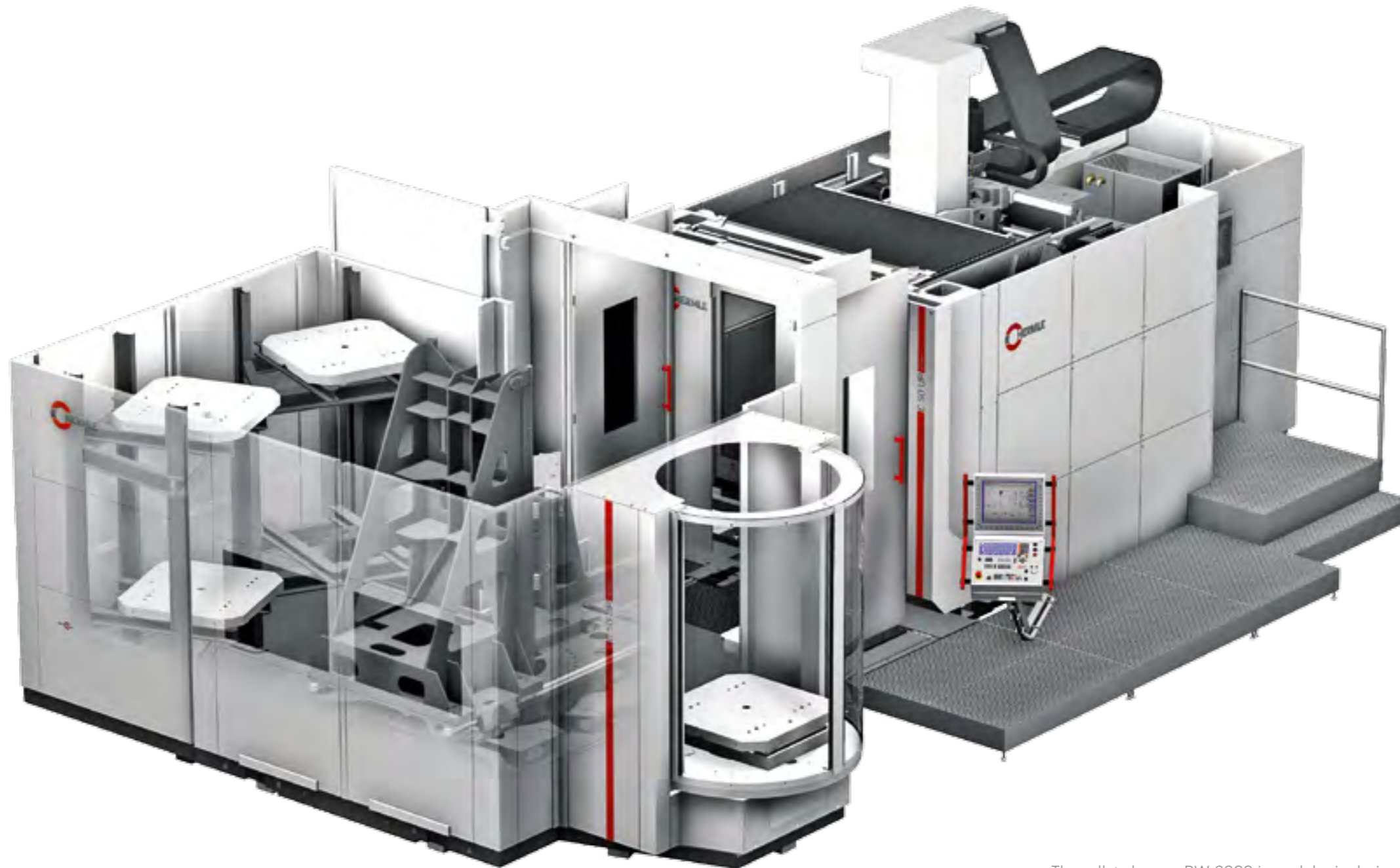

The pallet changer PW 3000 is modular in design. The storage and setup station modules can be configured to adapt to specific positions and quantities.

05 Precision



PRECISION IN EVERY DIMENSION: Hermle has a thorough understanding of the requirements for manufacturing high-precision machining centres for processing smaller and larger workpieces of up to 2.5 t in weight. For this reason, "The Original" only uses German machines for production and materials from European suppliers.

Furthermore, the entire machining production department is fully air conditioned and kept clean by a central swarf disposal system.

Hermle machining centres have also been thoroughly tested by intensive endurance tests and in manufacture-oriented machining processes in our own machining manufacturing department. Our meticulous manufacturing processes allow Hermle to set new precision standards which undercut those demanded by the DIN/ISO 10791 standard in every way.

At Hermle, we distinguish between positioning precision (accuracy with which a certain position within the working area can be pinpointed on one axis) and geometric precision.

The latter is significant for the precision of the entire machine – it encompasses the following factors:

- Positioning of linear and rotary axes
- Straightness and angular deviation of the linear axes
- Rectangularity and parallel alignment of all axes to one other
- Concentricity and axial run-out of the table
- Concentricity of the working spindle

The precision of Hermle machining centres originates during mechanical production and is not produced by subsequent electronic compensation. This further improves the precision of the individual axes (precision package 1 and 2).

www.hermle.de/precision



PRECISION LEVELS

Hermle standard:

X-Y-Z: Pos. tolerance $\leq 8 \mu$
 A: Pos. tolerance $\leq 16''$
 C: Pos. tolerance $\leq 9''$

Hermle improved precision*:

X-Y-Z: Pos. tolerance $\leq 5 \mu$
 A: Pos. tolerance $\leq 10''$
 C: Pos. tolerance $\leq 6''$

**To achieve improved precision, components must be selected with care. Tolerances must also be taken into account whilst the machine is still being constructed.*

Hermle also recommends the HSK-A 63 tool holding fixture, electr. heat compensation, an ICS recooling unit and two-sided A axis drive.

Test and operating conditions are as follows: air conditioned room (+20 °C, +/- 2 °C) and temperature fluctuation of only 0.5 °C in one hour or max. 2 °C within 24 hours.

IMPROVED PRECISION PACKAGES (ON DEMAND)

Precision package 1 (linear axes X, Y, and Z)

- Straightness optimisation
- Geometry adjustment and optimisation
- Straightness measurement
- X, Y, Z positioning accuracy Pos. tolerance $\leq 5 \mu$
- Laser measurement according to VDI/DGQ 3441 or ISO 230-2

Precision package 2* (rotary axes A and C)

- Table geometry
- Axial run-out bearings
- C axis position
- Adjustment of complete table
- Position of A and C axes relative to basic geometry
- Indexing precision A 10''
- Indexing precision C 6''
- Laser measurement according to VDI/DGQ 3441 or ISO 230-2

**Not available for MT variants.*

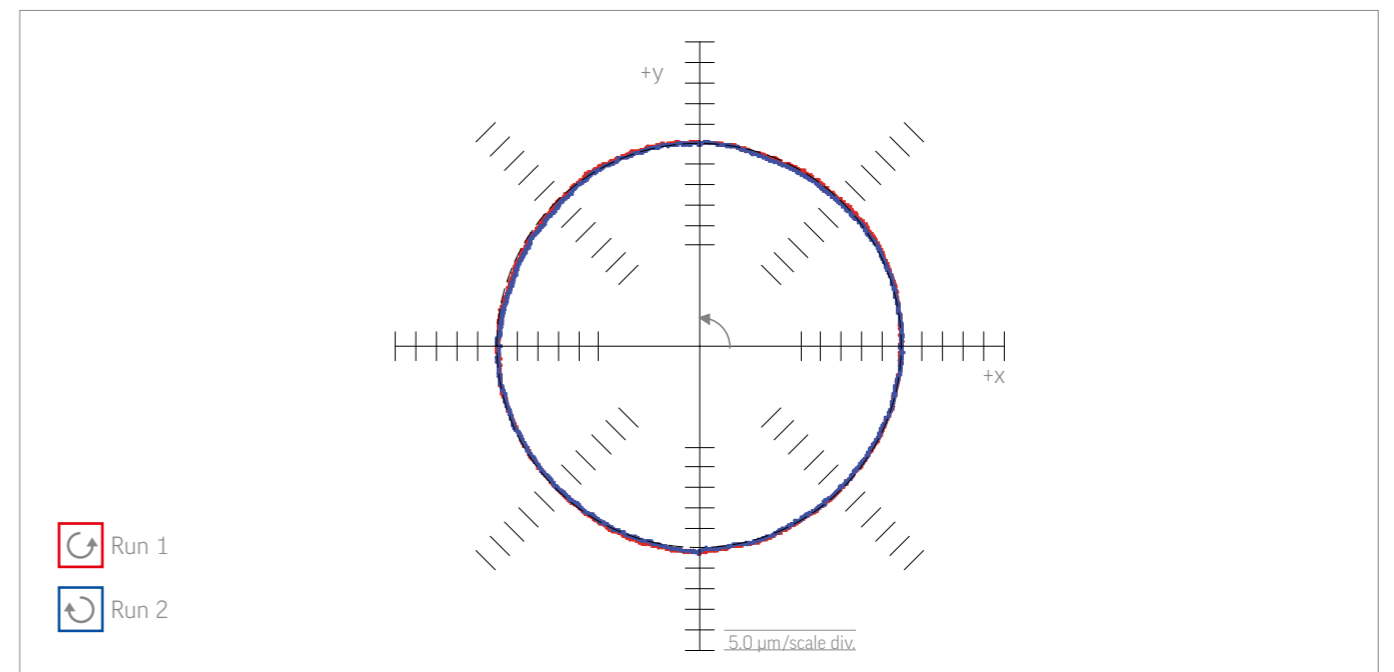

Ovality test of a standard machine

06 Energy efficiency

Both manufacturer and customer benefit from efficient production processes. Therefore, Hermle has focused on integrated resource sustainability and energy efficiency for many years. We can rightly claim pioneer status in the Blue Competence initiative founded by the VDW (German Machine Tool Builders Association).

From development to low-energy manufacturing (with a high level of in-house production) to the operation of CNC machining centres – Hermle has stood for a principle of sustainable environmental protection combined with economic considerations for many years. Energy recovery is just one of the advantages enjoyed by our customers.

www.hermle.de/energy-efficiency

BLUECOMPETENCE
Machine Tools



EFFICIENT MANUFACTURING

We use energy efficient manufacturing methods not because it is the current trend or because it is required of us, but on principle. And we always have.

Low energy component manufacture

- Mineral casting technology
- Lightweight construction

Virtual machine optimisation / machine development

Reduction in the energy required for transport through:

- High levels of in-house production
- Just one production plant
- Locally sourced components and materials
- No material tourism

High-quality, high-efficiency components

- Ball screws
- Guideways
- Antifriction bearing etc.

EFFICIENT OPERATION

Our machining centres are energy efficient both during their manufacture and during operation.

Energy recovery has been standard at Hermle for over 20 years

High quality servo axes

Ideal drive design for the respective application

Demand-based cooling technology both for dimensioning and in application

*De-energize system:
Up to 80% less energy consumption in stand-by mode*

Very long machine service life

07 Services

The perfection we insist on for the development and production of our machines is also mirrored by our service department. Our service team provides more than just spare parts and rapid response support within hours. At Hermle, we see ourselves as a comprehensive service provider which provides customers with numerous benefits.

Alongside standard services, these include:

- Our superior, cost-effective, practical and flexible training programmes carried out by sales representatives directly at the customers' premises.
- Our continual pursuit of optimisation and perfection. Our motto – those who stop improving today will not make the grade tomorrow.
- Intensive expert consultation on milling in general, programming and handling of our products.
- Our application technicians who are experts in machining processes and who are quick to assist and advise our customers.

www.hermle.de/services

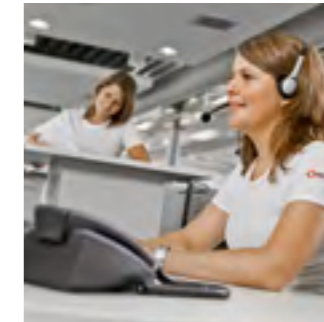

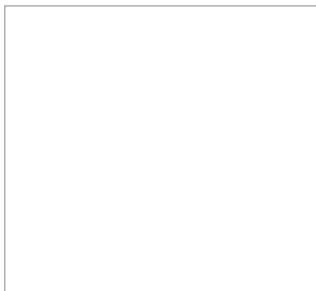

Maschinenfabrik
Berthold Hermle AG
Industriestraße 8-12
D-78559 Gosheim

Phone +49 (0)7426 95-0
Fax +49 (0)7426 95-1309

info@hermle.de
www.hermle.de

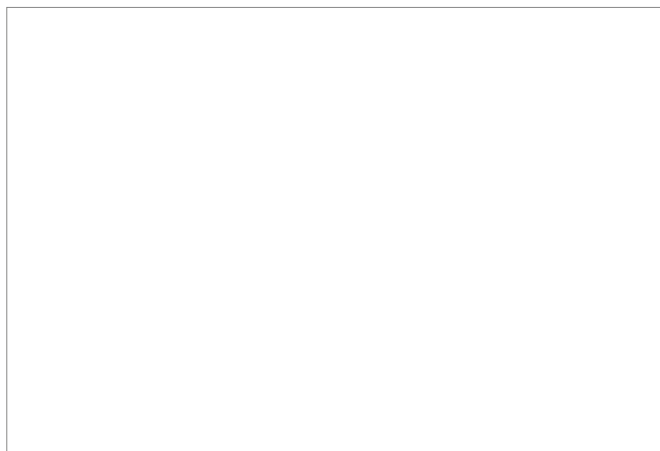

Subject to technical modifications. 06/13/C50/2000/EN/ST



The machining examples used in this leaflet are published with the explicit and kind permission of our customers. The information in this brochure only contains general descriptions and/or performance features that, in a concrete application, may not always apply in the form described or represented here or may have changed due to further development of the products. The performance features desired shall only be binding if they have been expressly agreed upon in writing at the time of the contract. The machines illustrated may include some options, accessories and control unit alternatives.