

DUO

Wire Electrical Discharge Machines

SERIES



DUO SERIES

Having a debate over WireGuide Selection?

Makino EDM has the Solution!

Dual Guide Option

You decide the best fit for your application



Split Precision Guide system

Wire diameter: ϕ 0.1, ϕ 0.15, ϕ 0.2, ϕ 0.25, ϕ 0.3 mm

Split Precision Guides use two separate PCD components mounted to ceramics. Split Precision is offered in V-Flat and C type configurations. Split Precision guides open during threading cycles, assuring AWT reliability. This low maintenance system also reduces operator intervention. Split Precision V-guide system is perfect for high production applications, while the Split Precision C Guides are the best solution for tapers up to 45 degrees.



AWT to 300 or 400mm-thick workpiece

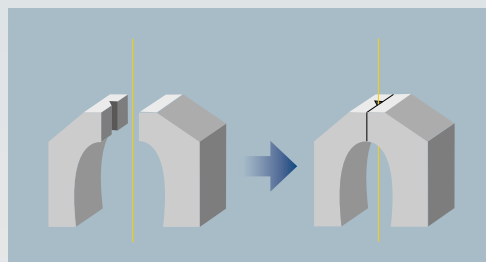

Split Precision guides perform reliable threading cycles in thick work pieces as a result of a larger target area while the guides are open.

Maximum plate thickness capable of automatic threading

Machine	Plate thickness
DUO43	300 mm
DUO64	400 mm



Common to Split Precision and PICO

High Speed AWT to 10 seconds

The optimal threading cycle can be selected according to the hole diameter and plate thickness. These threading options will increase the reliability and speed cycle of the Auto Wire Threading process.



PICO precision Guide system

Wire diameter: ϕ 0.1, ϕ 0.15, ϕ 0.2, ϕ 0.25, ϕ 0.3 mm

Pico Precision Guide System offers an innovative approach to closed round guides with high precision. Our Pico guides are specifically designed to cut Micro tapers with the highest possible accuracies. Initial start holes as low as 0.3mm are automatically threaded without failure. These guides also are able to successfully thread small holes located in very tight pitch locations.

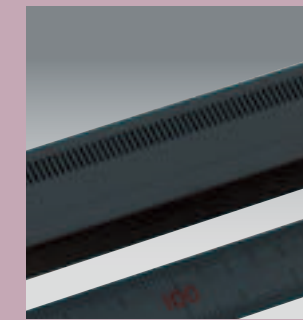

Wire used : ϕ 0.1 mm (BS)
 Plate thickness : 10 mm
 Diameter of start hole : 0.3 mm
 Pitch between start holes : 1.2 mm

Pecking feed system

Twin jet system

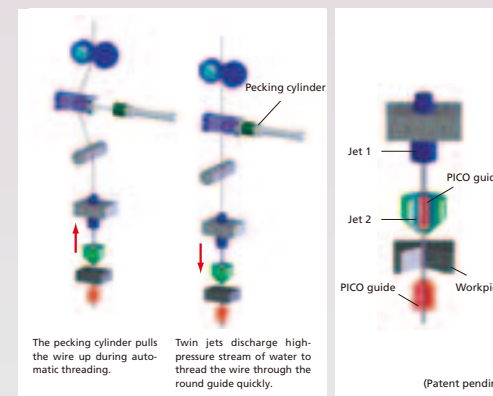

High performance twin-jet automatic wire threading system

The machines come with a twin-jet system that discharges small-diameter, high-pressure water jets through nozzles provided at the top and inside of the PICO guide on the upper head. The powerful twin jets and the wire pecking feed system thread the wire tip through the round guide at high speed. The wire tip removes any sludge sticking to the insides of the guide to achieve stable automatic threading at all times. Any burrs that develop at the wire tip are corrected to a shape that allows the wire to pass through. It is also possible to thread automatically at a breaking point of wire.

Retry Function

The retry function repeats the threading operation when threading failures occur due to a bent wire tip. If threading is not successful after a specified number of retries, the machine identifies that the wire tip is bent and moves to a position off of the workpiece and removes the bent tip. The wire is then returned to the machining position and machining is restarted.

Recovery From Wire Break function

This function automatically rethreads the wire and resumes machining following an unexpected wire break. Automatic rethreading is an essential function for unattended machining.

Both guides are selectable at the time of purchase. Please contact your Makino sales representative for guide change details after the time of purchase.

Wire Electrical Discharge Machines

DUO43

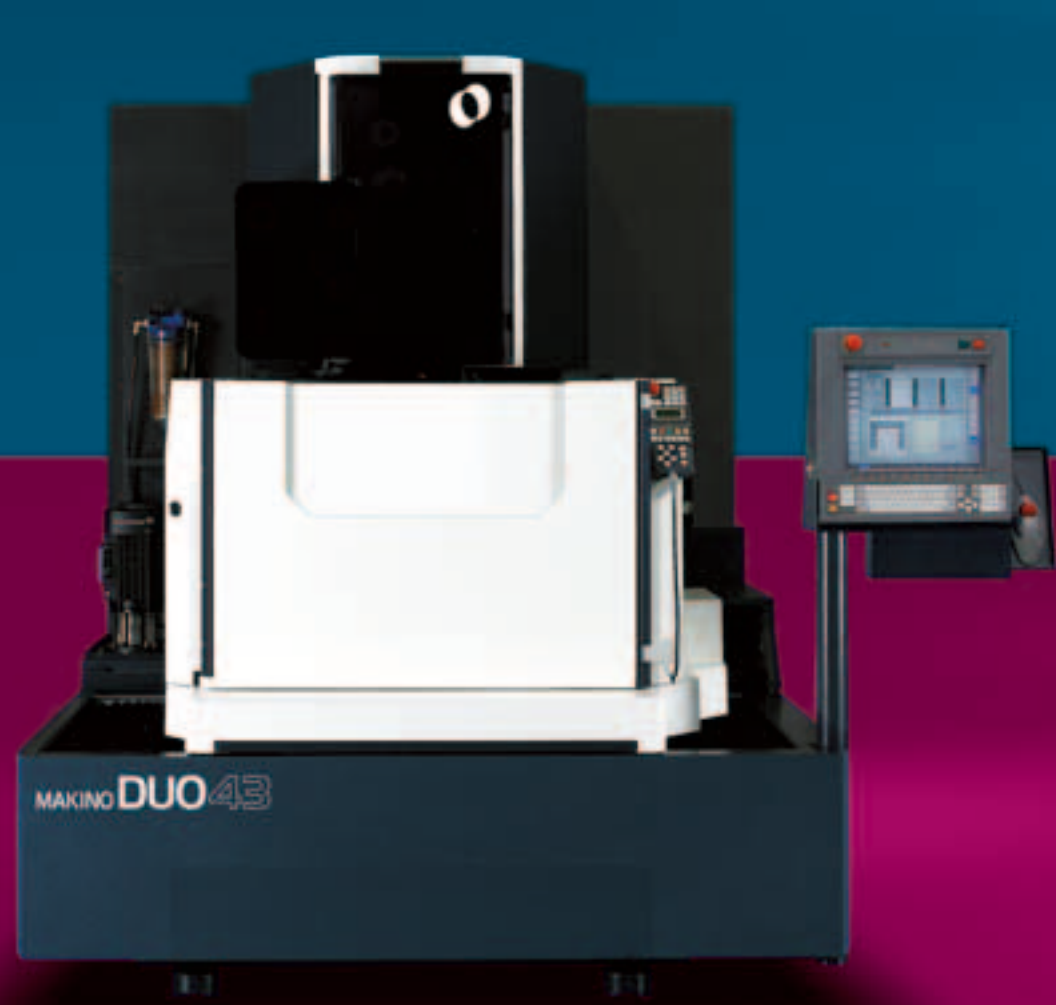

Small-footprint design

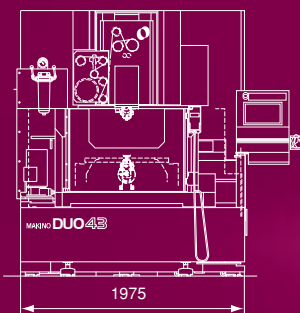

- Travels (X, Y, Z axes) ————— 450 × 300 × 320 mm
- Travels (U, V axes) ————— ±101 × ±101 mm (with limitation)
- Maximum dielectric fluid height — 365 mm
- Maximum workpiece size ————— 710 × 560 × 300 mm
- Maximum loading weight ————— 800 kg
- Wire electrode diameter ————— φ 0.1, φ 0.15, φ 0.2, φ 0.25, φ 0.3 mm

Wire Electrical Discharge Machines

DUO64

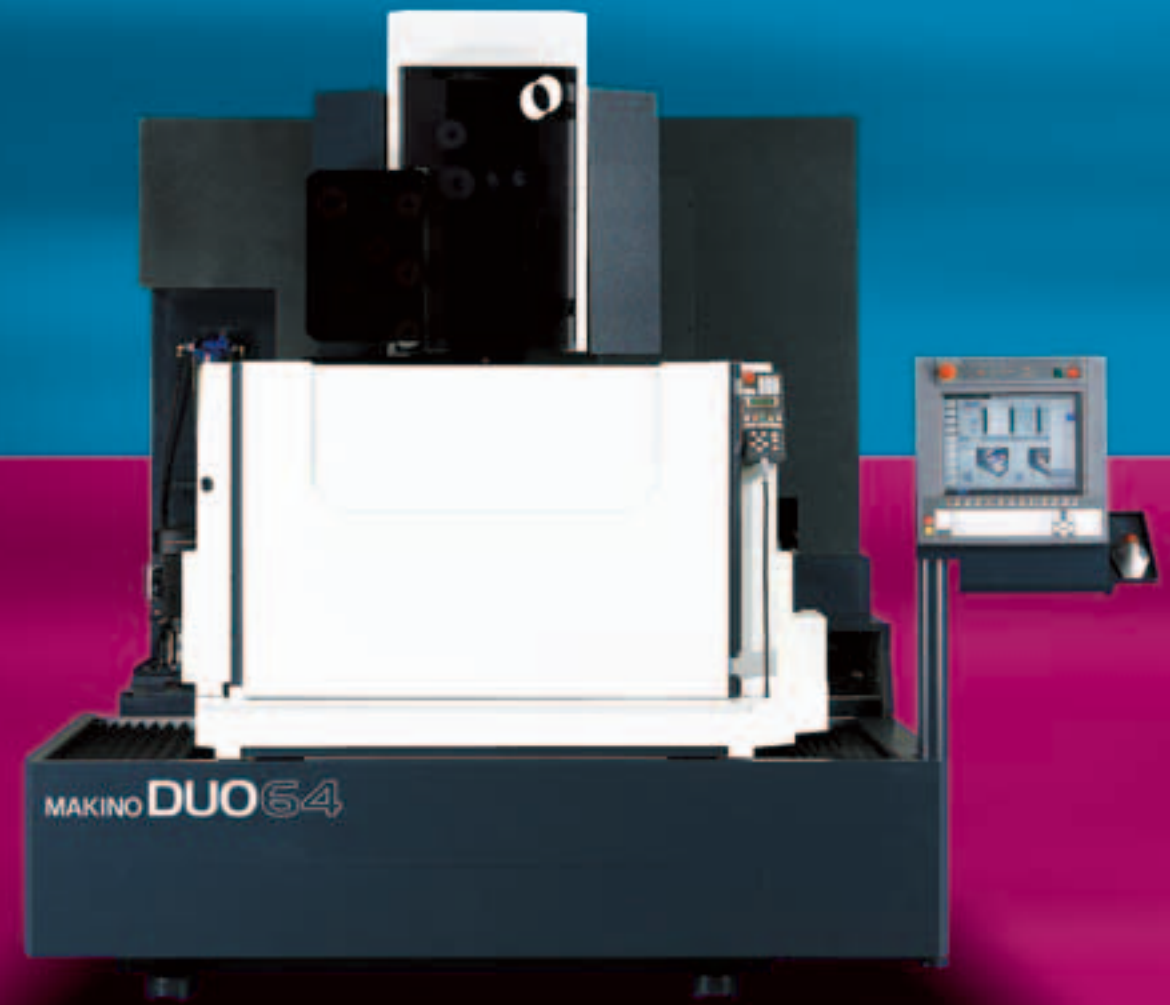

Small-footprint design

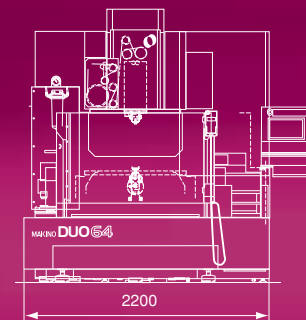

- Travels (X, Y, Z axes) ————— 650 × 400 × 420 mm
- Travels (U, V axes) ————— ±101 × ±101 mm (with limitation)
- Maximum dielectric fluid height — 465 mm
- Maximum workpiece size ————— 910 × 660 × 400 mm
- Maximum loading weight ————— 1200 kg
- Wire electrode diameter ————— φ 0.1, φ 0.15, φ 0.2, φ 0.25, φ 0.3 mm

Structure

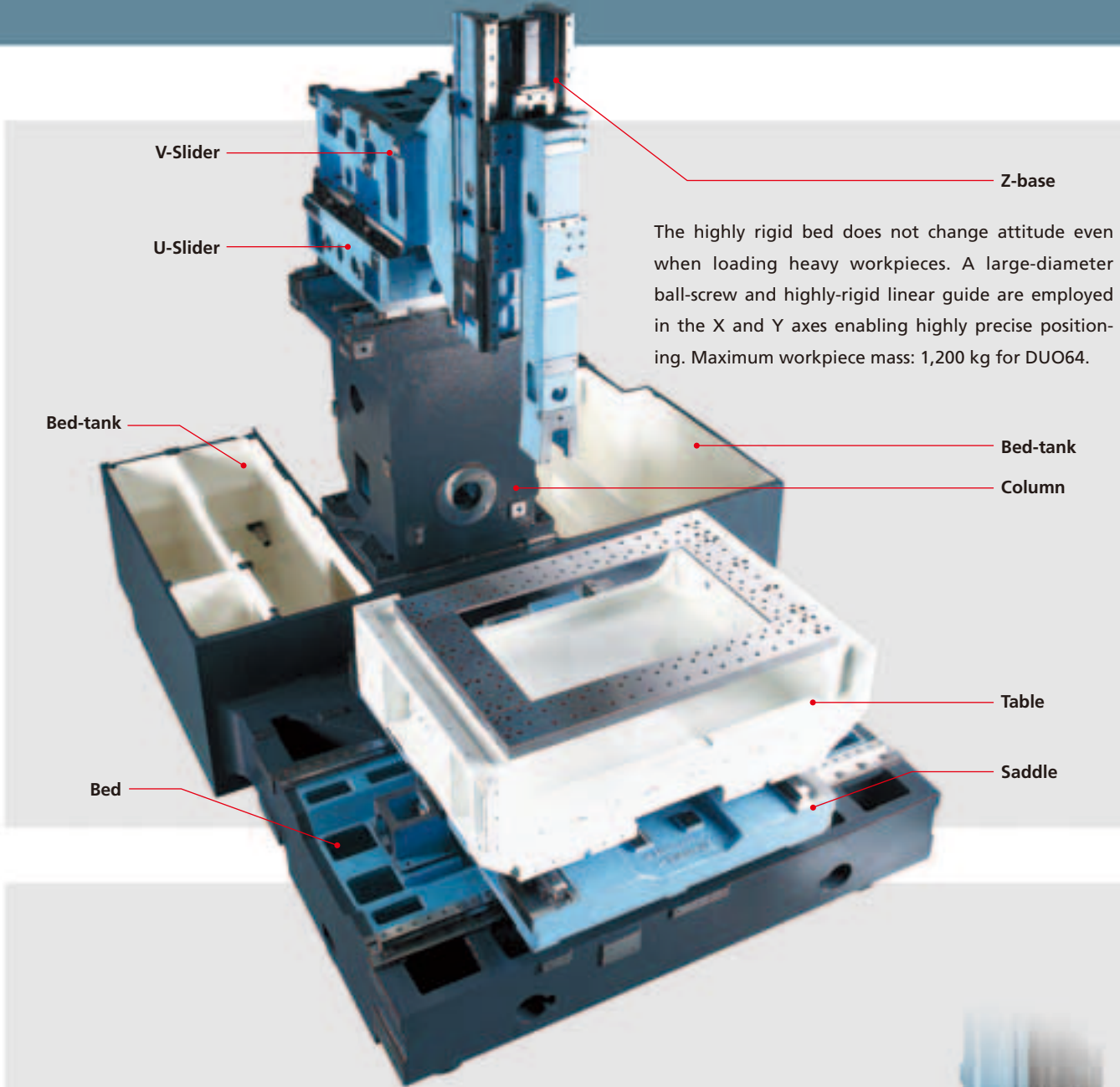

The highly rigid bed does not change attitude even when loading heavy workpieces. A large-diameter ball-screw and highly-rigid linear guide are employed in the X and Y axes enabling highly precise positioning. Maximum workpiece mass: 1,200 kg for DUO64.

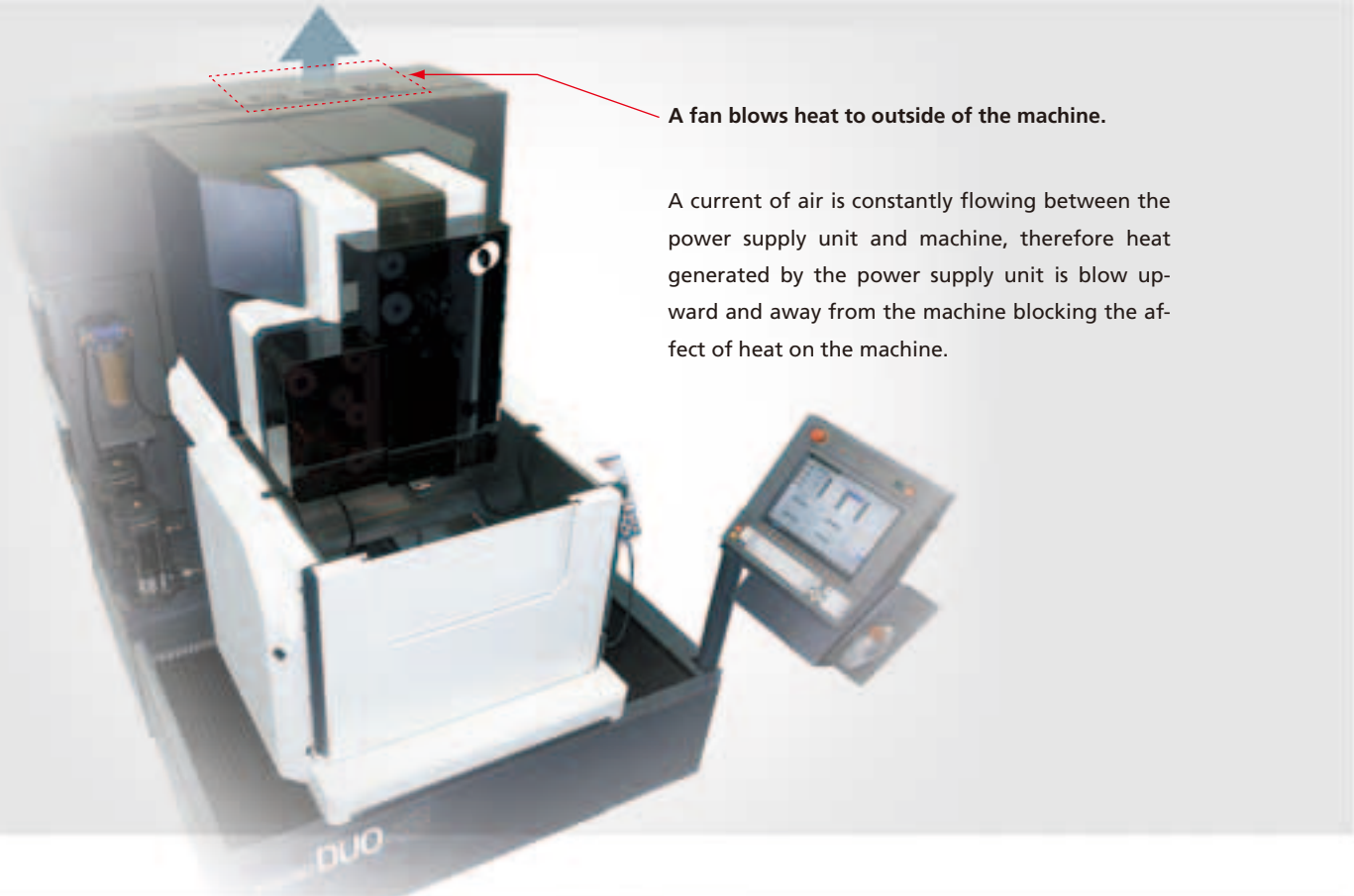

A large-diameter ball-screw and highly-rigid linear guide are also employed in the U, V and Z axes. This machine has been assembled to an optimum configuration using high-rigidity components, and therefore realizes high precision taper machining.

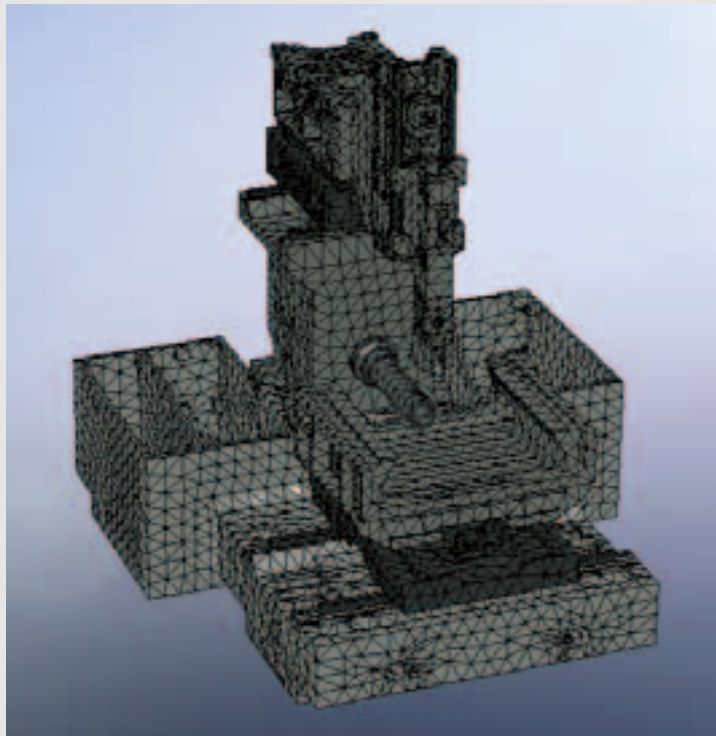

This machine has successfully realized high rigidity through finite element analyses and prototype testing. The bed which is the base of the machine, adopts a bed tank system designed to be integrated to the dielectric fluid tank. Dielectric fluid cooled by the cooling unit is fed to the bed tank. This synchronizes the temperature of the dielectric fluid with the bed. Therefore, the bed is unaffected by changes in ambient temperature or heat generated in the machining. This keeps the machine at a constant attitude.

High Speed

Extended uninterrupted machining



Makino's advanced technology can perform accurate machining without increasing the wire feed rate. Consumption of $\phi 0.3$ mm wire is reduced with DUO's new wire control. This is the same level of consumption as $\phi 0.25$ mm wire using conventional technology with the added advantage of $\phi 0.3$ mm wire cutting speed.

*The unit of "mm/5 kg" means "How long can the machine cut when you use only 5 kg wire."

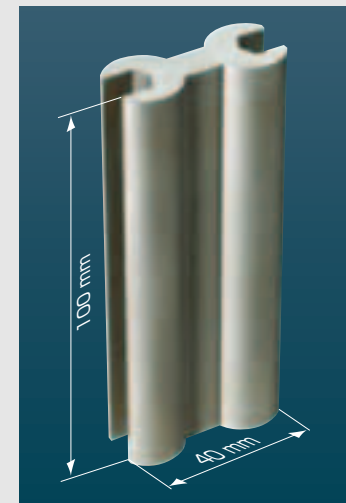
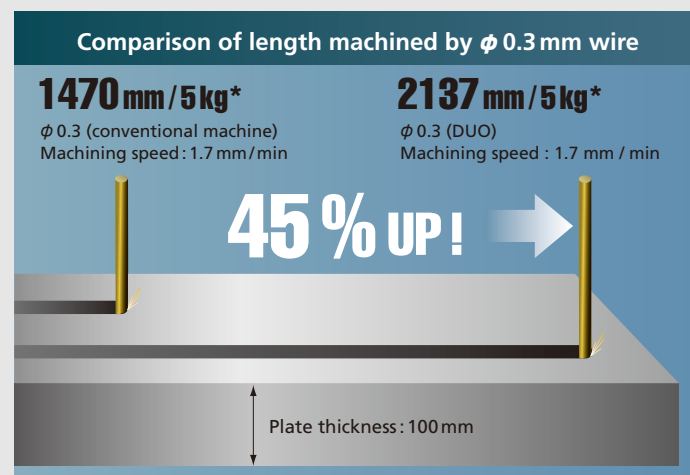

Comparison of wire consumption between $\phi 0.3$ mm wire and $\phi 0.25$ mm wire.

× 100 pcs.

Workpiece material : S55C (steel)
Plate thickness : 100 mm
Machining length : 150 mm
No. of machining passes : 1
No. of products : 100 pcs.
Machining condition : High speed machining condition

When using $\phi 0.25$ mm wire with conventional machine



Machining time: 185hr. 10min. (100pcs.)
Wire consumption: 5kg bobbin × 10

33% CUT!

When using $\phi 0.3$ mm wire with DUO

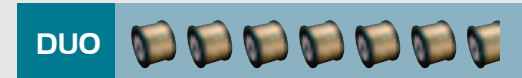

Machining time: **128 hr. 20 min.** (100pcs.)
Wire consumption: **5 kg bobbin × 6.7**

Maximum machining speed



DUO provides maximum machining speed 265mm²/min by using coated wire.

Maximum Machining Speed

Wire used	Wire used	
	brass	coated wire
	Actual machining speed	Maximum machining speed
$\phi 0.25$ mm wire	200 mm ² / min	230 mm ² / min
$\phi 0.3$ mm wire	230 mm ² / min	265 mm ² / min

Workpiece material : Steel Plate thickness : 60 mm

High speed finish machining



2nd High Speed Finish machining condition is up to 100% faster than conventional technology while maintaining the same level of accuracy.



Workpiece material : SKD-11 (steel)
Wire used : $\phi 0.3$ mm (BS)
Plate thickness : 80 mm
No. of machining passes : 2
Machining time : 30 min.
Surface finish : 15 μ mRz (2 μ mRa)

H.E.A.T.

High Energy Applied Technology

Fastest both nozzle away machining in the world



In two-nozzle separate machining, H.E.A.T. technology achieves an incredible machining speed of 130 mm²/min. The combination of a high-pressure jet and H.E.A.T. technology greatly reduces the machining time for workpieces that have uneven surfaces or workpieces where sufficient machining fluid cannot be supplied to the ends. In addition, the straightness for a 150 mm thickness plate after the first machining pass is a highly accurate 5 μ m (one side).

Compatible wire diameters: $\phi 0.25$, $\phi 0.3$ mm (brass wire will suffice)
Machining conditions: 25 to 300 mm plate thickness
There are also a wide range of second and third machining pass settings.

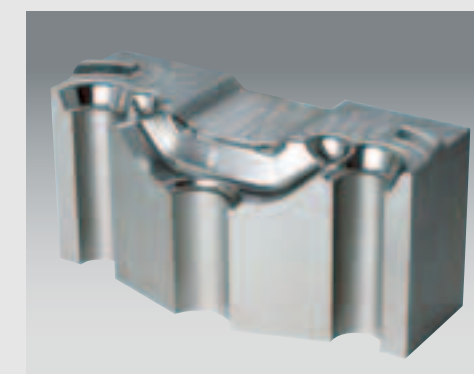
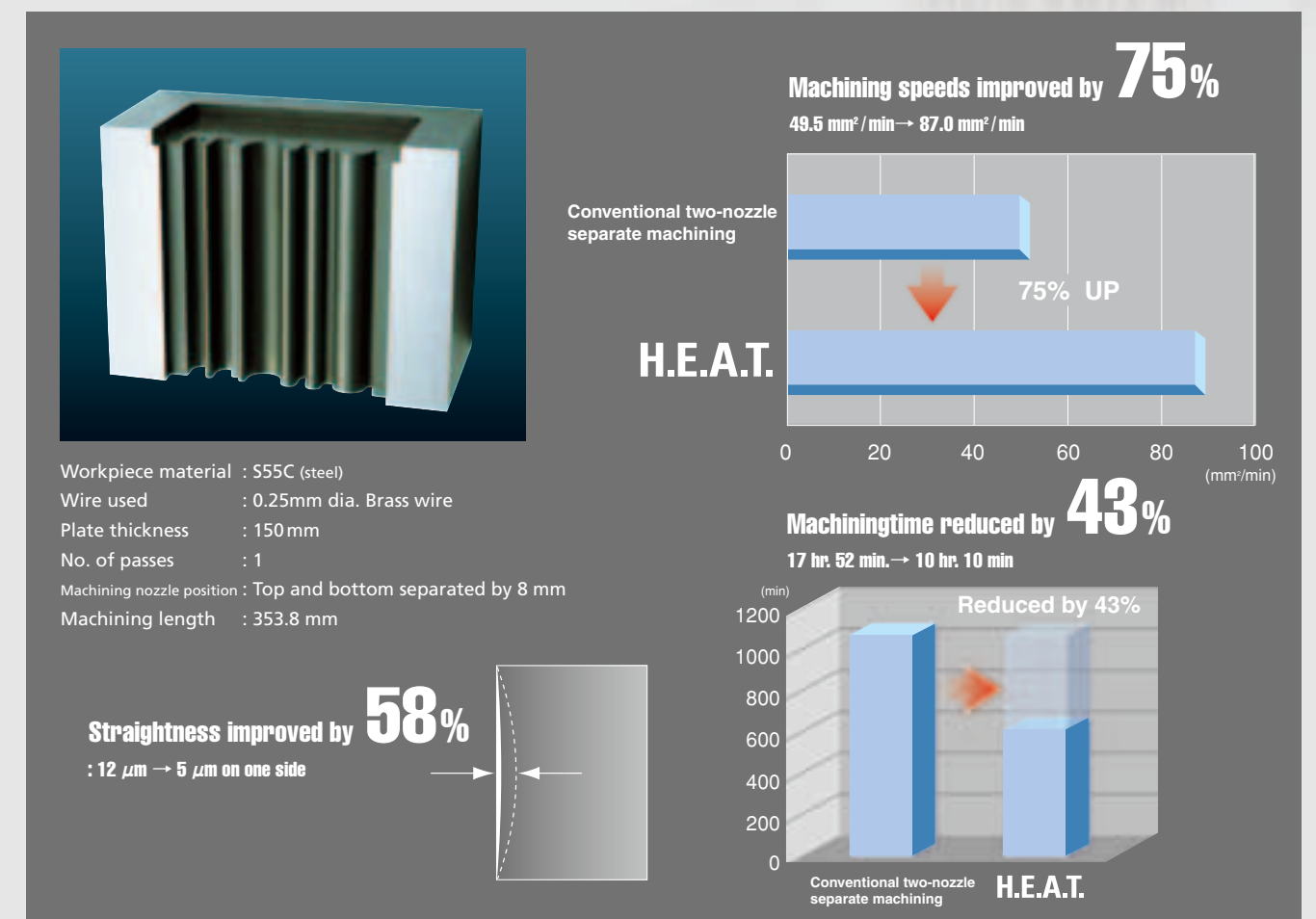

H.E.A.T. 3pass machining

Surface finished down to 10 μ mRz can be achieved in 3 passes with H.E.A.T. technology. Dramatic improvements in speed and accuracy are also realized with H.E.A.T. cutting conditions.

Workpiece material : STAVAX (stainless steel)
Wire used : $\phi 0.25$ mm (BS)
Plate thickness : 60~100 mm
No. of machining passes : 3
Machining speed : 1st 1.9-1.3 mm/min
2nd 7.8 mm/min
3rd 8 mm/min
Surface finish : 7.3 μ mRz (1.1 μ mRa)

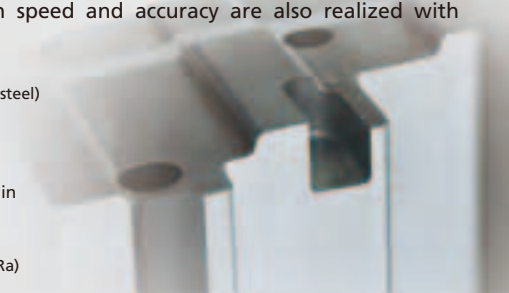

GS cut

Realizing a straightness tolerance of 5 μm (one side) with one machining pass with a workpiece plate thickness of 300 mm.

Makino's proven GS cut function incorporates improved cutting condition and servo control technology that is able to maintain precise part straightness in applications up to 400 mm thickness.

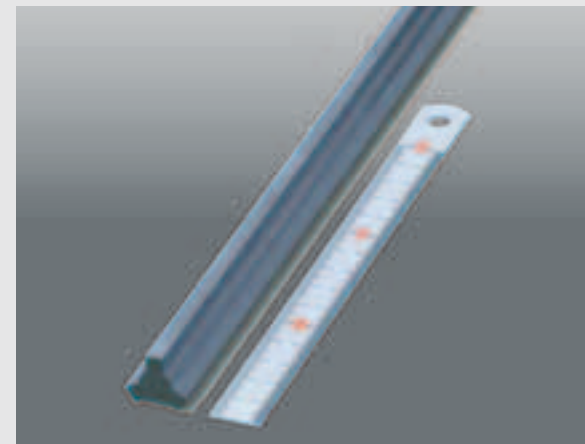
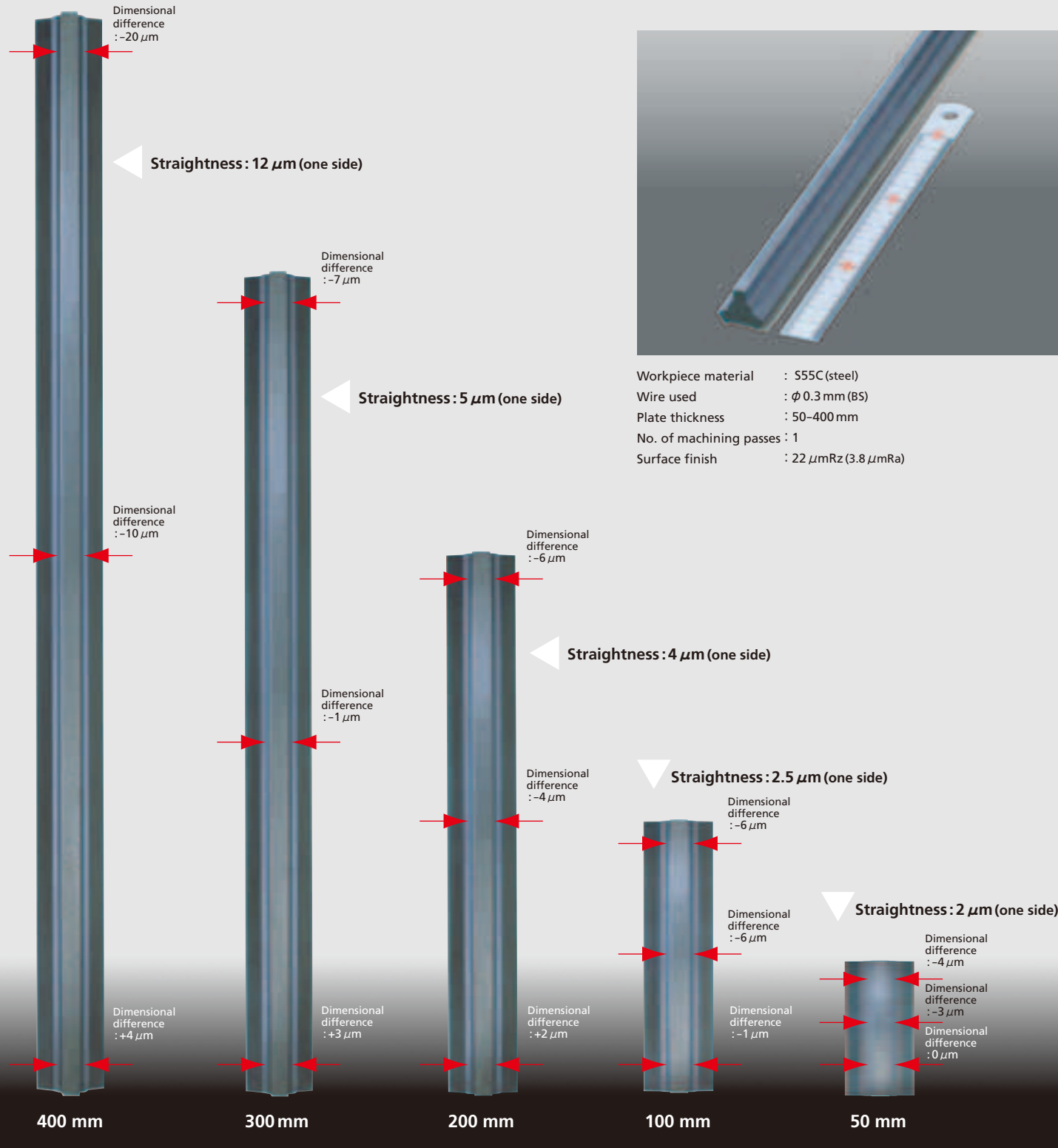

Workpiece material : S55C (steel)
 Wire used : ϕ 0.3 mm (BS)
 Plate thickness : 50-400 mm
 No. of machining passes : 1
 Surface finish : 22 μmRz (3.8 μmRa)

* Automatic wire threading success rates for wire exceeding 100 mm have been decreased with the PICO guide system specifications.

→ ← Dimension 5 mm

V-corner

Realizing highly accurate corners

Using proprietary wire control technology, corner accuracy is improved during the first pass and finish pass. In the first pass, wire feed delay is compensated for in real time. In the finish pass the wire is controlled so that the amount of material removed at the inner and outer corner is constant at all times. This results in highly accurate corner geometry.

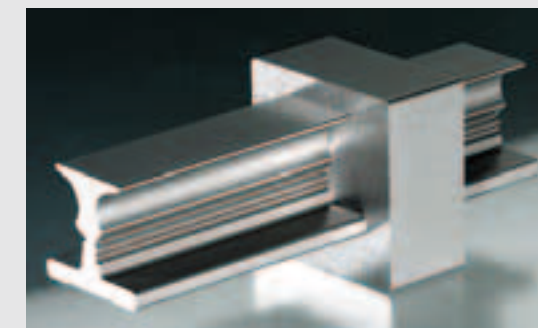
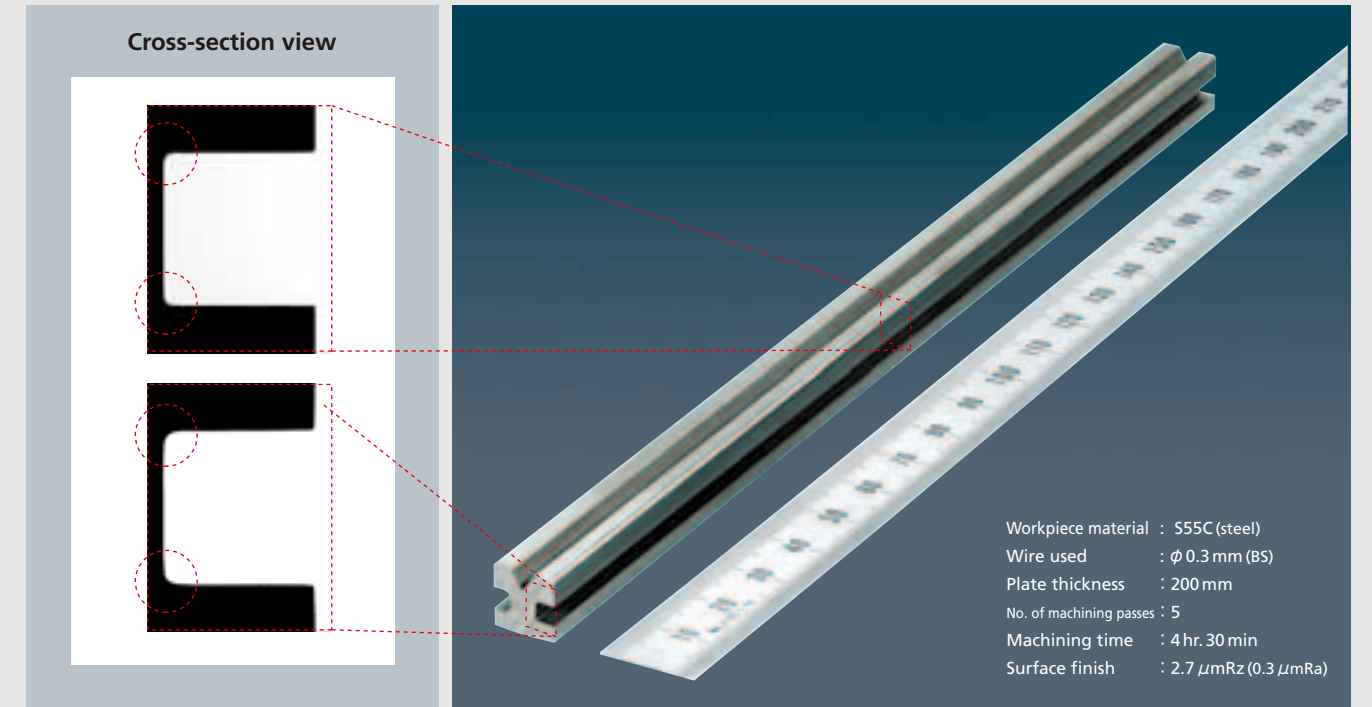

Workpiece material : SKD-11 (steel)
 Wire used : ϕ 0.3 mm (BS)
 Plate thickness : Punch 80 mm Die 15 mm
 No. of machining passes : 5
 Machining time : Punch 2 hr. 20 min. Die 1 hr.
 Surface finish : Punch 2.2 μmRz (0.3 μmRa)
 Die 1.8 μmRz (0.2 μmRa)

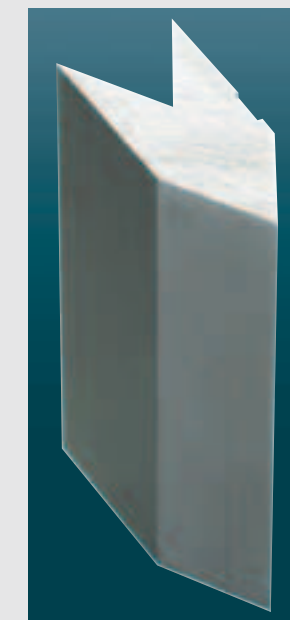

Workpiece material : SKD-11 (steel)
 Wire used : ϕ 0.2 mm (BS)
 Plate thickness : 40 mm
 No. of machining passes : 5
 Machining time : 1 hr. 30 min.
 Surface finish : 2.5 μmRz (0.3 μmRa)

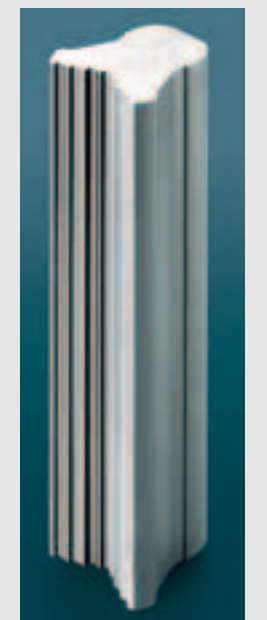

Workpiece material : SKD-11 (steel)
 Wire used : ϕ 0.3 mm (BS)
 Plate thickness : 80 mm
 No. of machining passes : 5
 Machining time : 1 hr. 45 min.
 Surface finish : 2.7 μmRz (0.3 μmRa)

T.G control

Perfect control of thickness and gaps

Highly accurate machining can be realized even with work pieces that have complex thickness transitions. Makino's new TG control technology minimizes dimensional differences caused by varying plate thicknesses thus eliminating lines in stepped sections while maintaining part straightness.

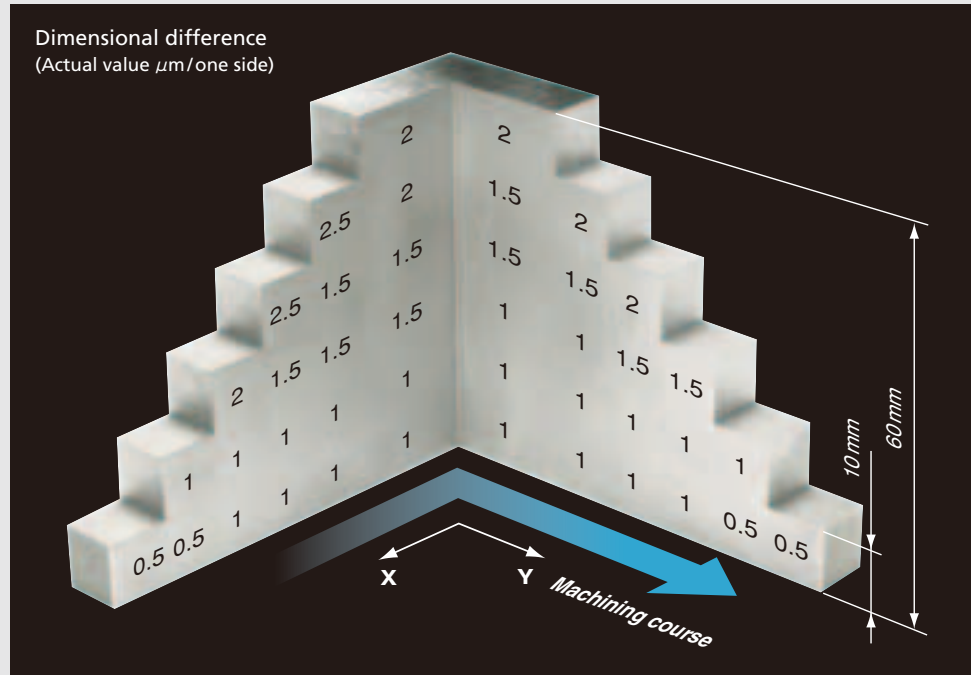

Workpiece material : SKD-11 (steel)
 Wire used : ϕ 0.2 mm (BS)
 Plate thickness : 10-60 mm
 No. of machining passes : 2
 Surface finish : $12\mu\text{mRz}$ ($1.7\mu\text{mRa}$)

There are also a wide range of second and third machining pass settings.
 Compatible wire diameters: ϕ 0.2, ϕ 0.25 mm (brass wire will suffice)
 Machining conditions:
 (1) 10 to 60 mm plate thickness
 (2) 40 to 100 mm plate thickness
 (3) 5 to 20 mm plate thickness
 Surface finished down to $7\mu\text{mRz}$ ($1.1\mu\text{mRa}$) can be achieved in 3 passes with TG control.

There is no difference in straightness and surface finish even with different machining directions.

- Machining from the higher to lower levels of a workpiece.
- Machining from the lower to higher levels of a workpiece.
- Machining in different axis directions, such as X and Y.

Two flushing pumps

Flushing pumps give precise control to upper and lower head water jets during Automatic Wire Threading as well as during the erosion process. This negates the use of multiple valves to control this process as this is usually very unstable.

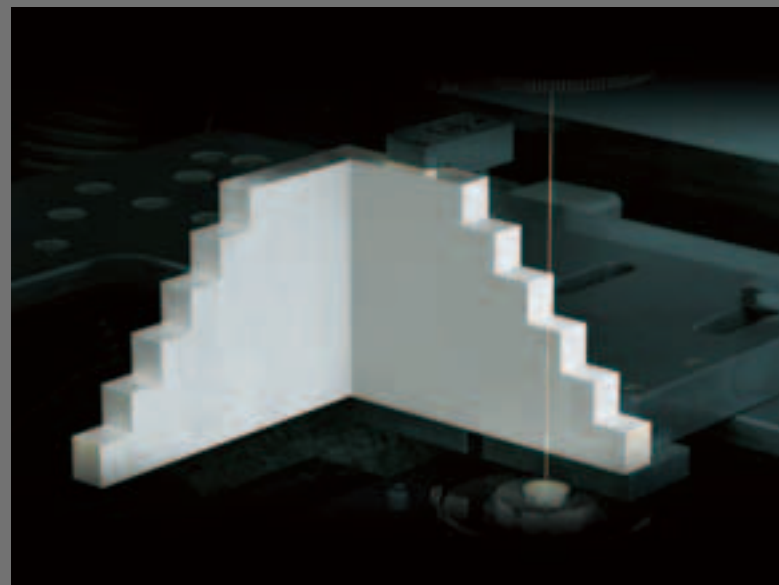

Taper Machining

Micro taper machining



The PICO guide system facilitates high-accuracy machining of micro tapers. This new guide system, combined with precise servo control, produces uniform machining along the entire length of the cut detail.

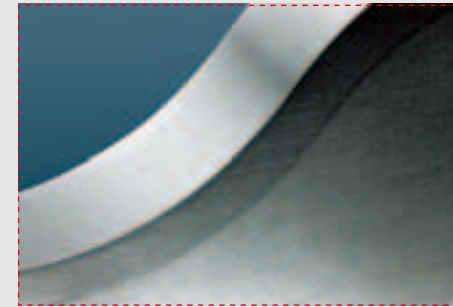

Workpiece material : STAVAX (stainless steel)
 Wire used : ϕ 0.2 mm (BS)
 Plate thickness : 15-30 mm
 No. of machining passes : 4
 Surface finish : $3.8\mu\text{mRa}$ ($0.55\mu\text{mRa}$)
 Length of straight portion : 2 mm
 Taper angle : 1°

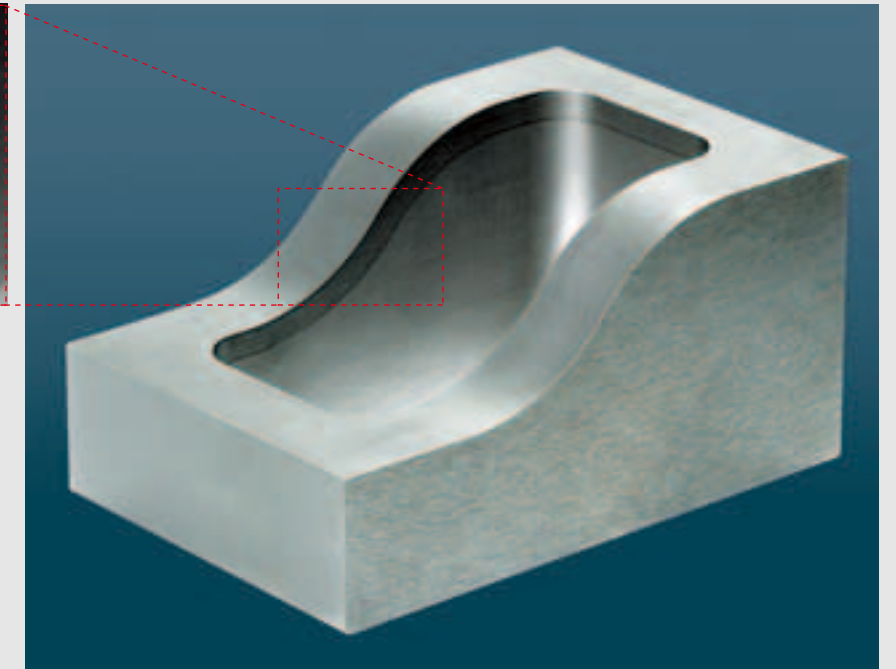

Angle-Cut



The maximum taper angle is increased to 45° by using Split C-guides and special wire electrodes.



Workpiece material : S55C (steel)
 Wire used : ϕ 0.2 mm (coated wire)
 Plate thickness : 80 mm
 No. of machining passes : 3
 Machining time : 7 hr.53 min.
 Surface finish : $7\mu\text{mRz}$ ($1.1\mu\text{mRa}$)
 Taper angle : 8°

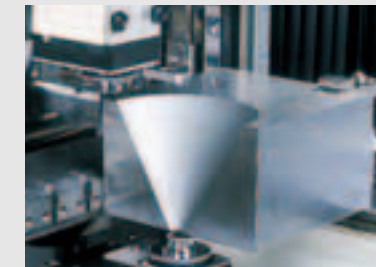

AS control

Makino's AS control technology facilitates more accurate taper machining. A machining trial is performed to execute the basic shape for the three patterns of arbitrary angle compensation, cutting edge compensation and parting direction compensation. The measured results are then fed back to enable taper machining according to the accuracy standard of the measuring instrument used.

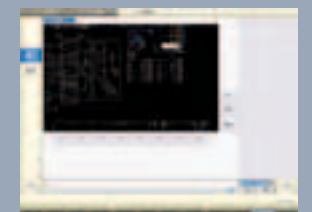

Best surface finish

Best surface finish



DUO provides superior surface finishes to $1.8 \mu\text{mRz}$ ($0.2 \mu\text{mRa}$) with "Precision Machining conditions"

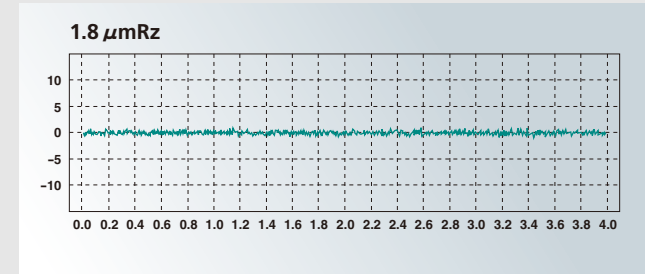

Workpiece material : SKD-11 (steel)
 Wire used : $\phi 0.2 \text{ mm}$ (BS)
 Plate thickness : 20 mm
 No. of machining passes : 5
 Surface finish : $1.8 \mu\text{mRz}$ ($0.2 \mu\text{mRa}$)

Surface finish of $7 \mu\text{m Rz}$ with the first machining



It is possible to attain a surface finish of $7 \mu\text{m Rz}$ with the first machining by using "Roughing 10 Machining."

This is effective for working with thin materials that can easily become deformed if machined many times. There is almost no need for treatment of traces of cuttings, and that means subsequent processes can be eliminated.



Workpiece material : SKD-11 (steel)
 Wire used : $\phi 0.2 \text{ mm}$ (BS)
 Plate thickness : 3 mm
 No. of machining passes : 1
 Surface finish : $7 \mu\text{mRz}$ ($1.1 \mu\text{mRa}$)

Custom pitch function



High-accuracy pitch machining is performed at the accuracy standard of the measuring instrument used. This is accomplished by simply entering in advance the targeted pitch accuracy and the measured results obtained in actual machining.

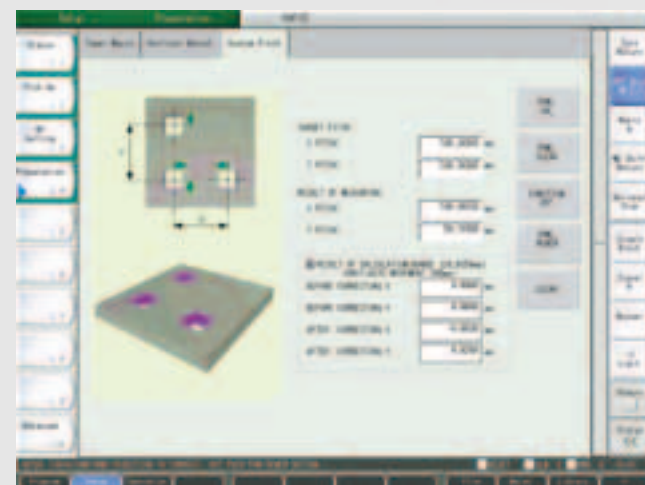

Functions

NC index unit



NC index unit provides effective machining by reducing setup time.

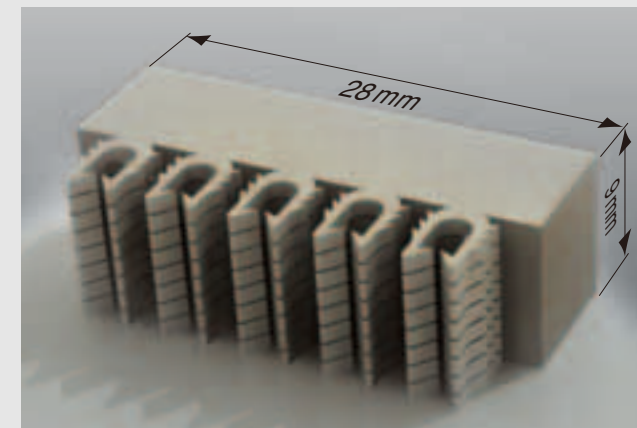

Workpiece material : titanium
 Wire used : $\phi 0.1 \text{ mm}$ (BS)
 No. of machining passes : 1st process 1 2nd process 4
 Machining time : 5min. 30sec. Per unit
 (When machining 40 units)
 Surface finish : $6.7 \mu\text{mRz}$ ($1 \mu\text{mRa}$)

Repeat positioning accuracy of $\pm 2 \mu\text{m}$ during edge pick up.



Improvements in the design of the touch sensing circuit allows repeat positioning accuracy for edge pick up of $\pm 2 \mu\text{m}$, even with the work tank filled.

Collision Protection



Electrically conductive nozzle guards detect electrical contact with jigs, fixtures, and workpieces preventing costly head crashes.



LL Generator Circuit



Specialized LL circuitry allows electrolysis free cutting in titanium alloys, carbides, PCD, CBN, and other materials that can show changes in surface integrity after the EDM process without this technology.

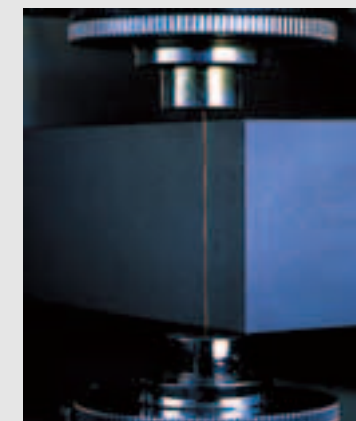
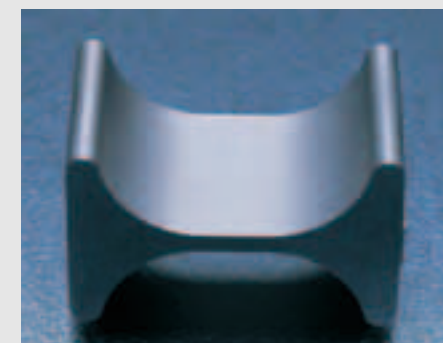

Speeding up function during nondischarge situation



This function provides increase of feedrate automatically during non-discharge, monitoring the discharge state in machining. It also reduces nondischarge time with higher machining efficiency.

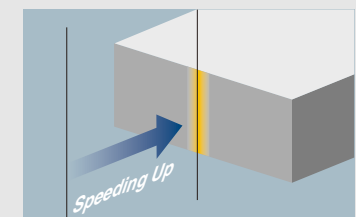

Ease of operation



Accessibility

Foot space is ensured to enable toes to fit between the machine and floor. Setting up mid-to-small workpieces and maintenance of the head and the like are easier because it is possible to access the table without an awkward posture.



Work tank door

It is effective to use the work tank door to attain a larger opening than the width of the table, when setting up large workpieces.

Sliding Window

The sliding window is convenient for simple work, such as setting mid-to-small workpieces that can be held in hand, or core processing. Opens with one touch, even if one hand is filled with the workpiece or tools. Employs a locking function that will not allow opening until the fluid surface has dropped to a safe level, even if the button is accidentally pressed.



The main work tank door allows easy loading of large workpieces on to the table. The square shape table assists in easy placement of larger workpieces for quick set-ups.

Ease of operation

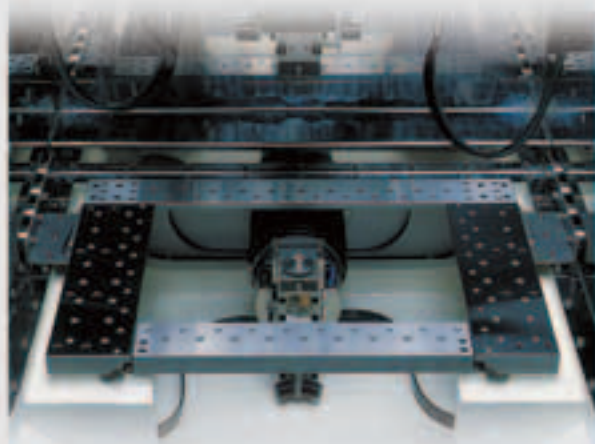

Square-shaped Table

The square-shaped table is adopted as standard. This supports longer workpieces and the handling of some pieces. The opening under the table is designed to be large, this improves the approach to the lower head, and will not impair maintenance.



Revolving-type Control Panel

The control panel revolves, so it can be set at a position that is easy to use when setting up the workpiece.

Height adjustment of the control panel

The control panel can be adjusted to three levels when setting up the machine. Daily machine operations are more efficient if the control panel is set to a position that is best for the operator.

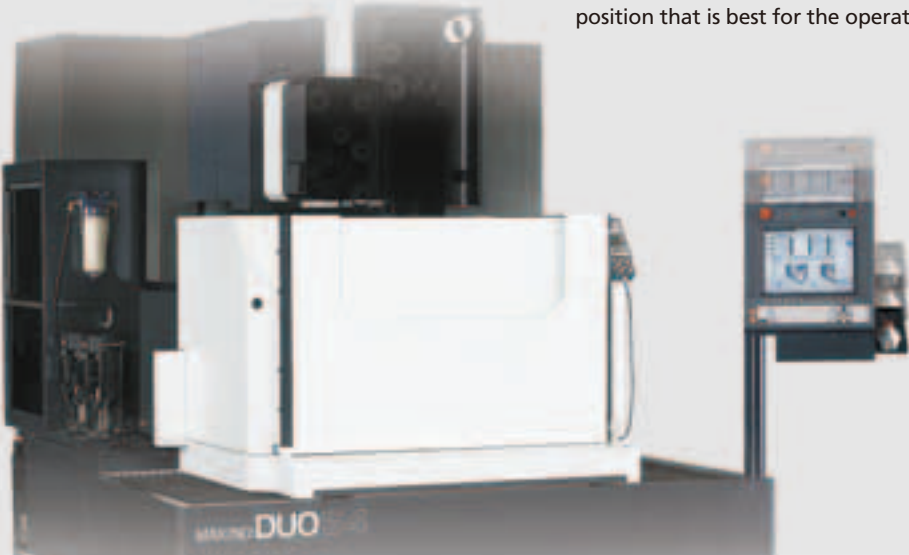

15 inch touch panel and mouse

The control panel has both a touch screen and mouse. It is possible to adjust the position of the control panel in accordance with work requirements and operator flexibility.



Portable multifunction control panel

Makino provides a multifunction portable hand box with digital readout for the operators convenience during set-up. This is standard equipment on all Makino WEDMs.

USB compatible

The USB port mounted on the control panel allows easy downloading of data at the machine from USB flash memory devices.

WIRE NAVI

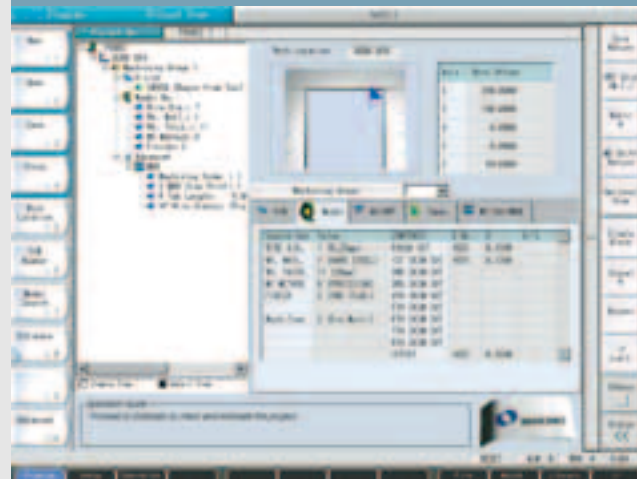

PROJECT

This screen is used to set the program and machining setting method.

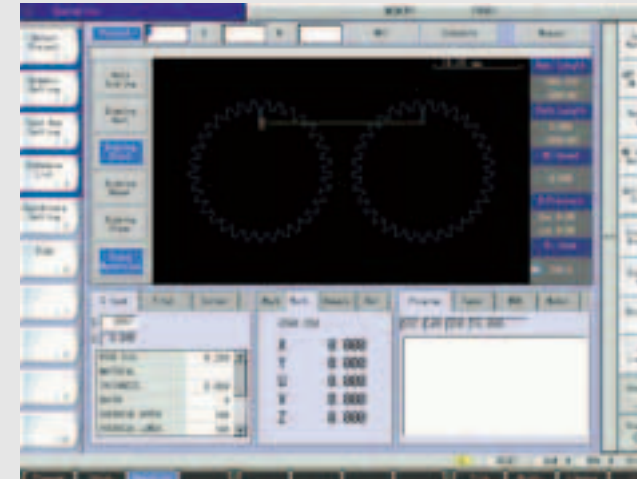

OPERATION

Information relating to the status of machining operations is centralized on one screen. The status of process of machining can be ascertained through the upper level graphics. Also, the lower level makes it possible for the operator to check machining conditions, the coordinate system and project settings.

1. Select the wire diameter.
2. Select the wire material.
3. Select the plate thickness.
4. Select the machining method according to the wire shape.
5. Select the finishing method for the targeted surface finish.

Operators can simply select the optimum machining conditions from a wide variety of machining conditions

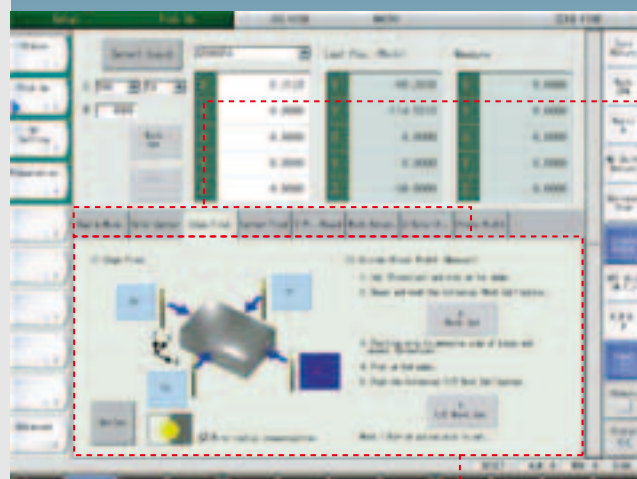

SET UP

Workpiece setting work has been consolidated on to one screen.



Measurement pattern display

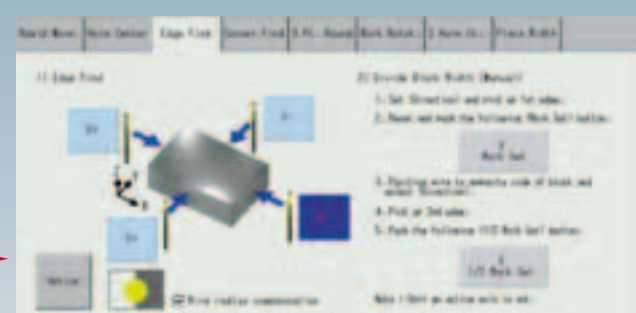

A detailed and easy explanation is provided for the procedures to perform actual measurements.



Custom Screen

Operators can make shortcuts to heavily-used buttons in their preferences.



Soft Limits

Soft axis travel limits can be set according to work-piece specifications preventing accidental head crashes during machine movements.

Guide cleaning

After sludge Removal

Removal of sludge

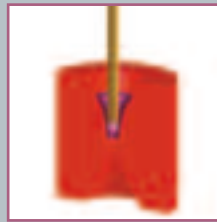

Sludge that sticks to the PICO guide can become an abrasive that causes guide wear. The twin-jet system removes sludge from PICO precision guide system every time automatic threading is done. This feature works to maintain high accuracy over long periods of use.



Because Split Precision Guides can be opened, this allows for easy and quick cleaning.



Maintenance of the energizing plate

Adequate space can be ensured for the approach to the lower head, and adjustments of the energizing plate are easily performed with the workpiece mounted. There is no need to align the wires vertically after adjusting the energizing plate

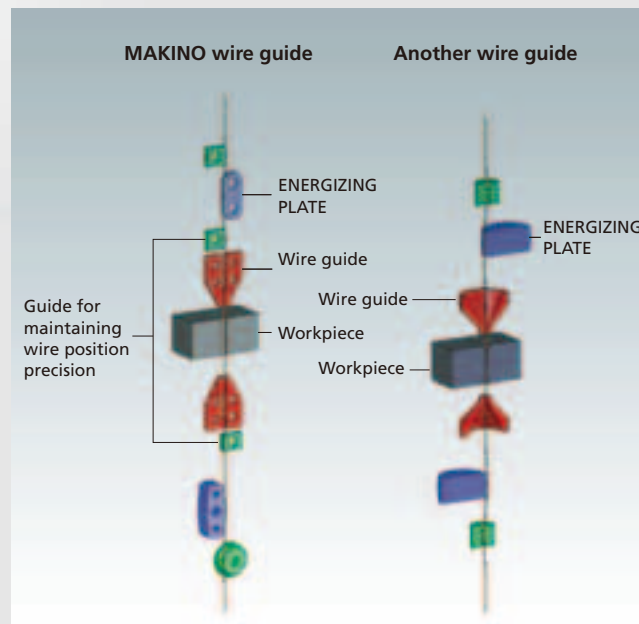

Makino Pre-Guide Technology



Makino's wire guide system has an additional Sapphire V guide positioned between the Wire Guide and the energizer plate. This assures proper contact of the wire to the energizer as the energizer wears.



Changing filters

Four filters are standard specification. Adopts a non-immersion type system that is not setup in water. Moisture captured in the filter is blown away by air, so compared to conventional immersion methods, this method reduces the weight of used filters making them easier to handle.

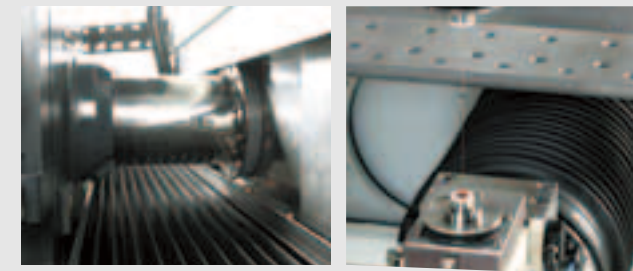

Arm seal

Lower arm is completely sealed and maintenance free.



Air is blown by pressing the button. This blows moisture captured in the filter.



Wire Box

The wire box is provided a full cover. Wire is securely recovered. Makino's WEDM has a system that discharges wire after removing moisture, so water does not build-up in the wire box. This makes it possible to work without soiling worker hands.

Maintenance diagnostic function

The replacement interval for consumables is indicated on the screen along with items requiring regular inspection.

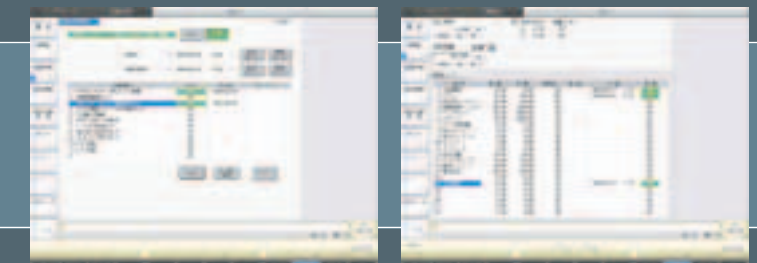

Equipment and Construction Work for Machine Installation

1. Floor area and foundation work

	Required installation space (including maintenance area) mm		
	Width	Depth	Height
DUO43	1975	2815	2250
DUO64	2200	3140	2422

It is recommended that a foundation be prepared for installing a machine, because a solid foundation is essential for maintaining high accuracy.
Allowable vibration :0.7 m/s² (0.07G) maximum

2. Factory air-conditioning equipment

Recommended optimal temperature :20 ±1°C

	DUO43	DUO64
Heat release rate kw (kcal / h)	10.8 (9287)	10.8 (9287)

Operating temperature range: 10°-35°C
Relative humidity: 75% maximum (without any condensation)

3. Measures against electromagnetic interference

It is recommended that EDM machines be installed in a shielded room to avoid electromagnetic interference. In addition, use of the optional power supply line filter is recommended if there is a possibility that electromagnetic noise from the power supply line might affect the operation of other equipment.

4. Electrical work

	DUO43	DUO64
Power supply specification	AC 3-phase, 200 V ±10%, 50/60 Hz, ±2% power factor	
Total power consumption (kVA)	18	18
Breaker capacity (A)	50	50
Circuit breaker	50 mA current sensitivity for the inverter circuit (when not installed in a shielded room)	
Power line size (mm²)	14	14
Recommended grounding	Class C grounding using 14 mm²ground wire (maximum ground resistance of 10 Ω)	

5. Provision of compressed air supply

0.6 MPa, 100 L/min (equivalent to a 1.5 kW compressor)
Connection port: 8 mm dia. high coupler (standard equipment)

6. Provision of water supply

An automatic water supply unit is available as optional equipment for controlling the fluid volume of the dielectric fluid supply unit automatically. A water supply source will be necessary if the automatic water supply unit is used.
Hose connection port: 17 mm dia. hose coupling

7. Factory environment

The following factory environment is recommended for maintaining high machine accuracy at all times.

- EDM machines should be isolated from equipment that produces dust.
- EDM machines should not be exposed to direct sunlight or discharges from an air-conditioning system.
- EDM machines should not be partially heated by a stove or other heating device.



Makino Milling Machine Co., Ltd.

Head Office

3-19 Nakane 2-chome, Meguro-ku, Tokyo 152-8578, Japan Tel: +81(0)3-3717-1151 Fax: +81(0)3-3725-2105 URL <http://www.makino.co.jp>

Atsugi Works International Operation Department

4023 Nakatsu, Aikawa-machi, Aiko-gun, Kanagawa 243-0303, Japan Tel: +81(0)46-286-6748 Fax: +81(0)46-286-4334

Makino J Co., Ltd.

4007 Nakatsu, Aikawa-machi, Aiko-gun, Kanagawa 243-0303, Japan Tel: +81(0)46-286-8350 Fax: +81(0)46-286-8385

Makino Inc.

7680 Innovation Way, Mason, Ohio, 45040, U.S.A.
Tel: +1-513-573-7200 Fax: +1-513-573-7360 URL <http://www.makino.com>

Makino Inc. Auburn Hills

2600 Superior Court, Auburn Hills, MI 48326
Tel: +1-248-232-6200 Fax: +1-248-6201 URL <http://www.makino.com>

Makino Europe GmbH

Makino GmbH
Business Unit Production Machinery / Business Unit Services
Essener Bogen 5, 22419 Hamburg, Germany
Tel: +49(40) 298 090 Fax: +49(40) 298 09 400 URL <http://www.makino.de>

Makino GmbH
Business Unit Die & Mould
Kruichling 18, 73230 Kirchheim unter Teck, Germany
Tel: +49(7021) 503 0 Fax: +49(7021) 503 400 URL <http://www.makino.de>

Makino France S.A.S.

Z.A. Les Bordes, 21, rue Gustave Madiot 91070 Bondoufle, France
Tel: +33(169) 116396 Fax: +33(169) 116399 URL <http://www.makino.fr>

Makino Italia Srl

Via Codognino Laudense, 40 26854 Cornegliano Laudense, Italy
Tel: +39(0371) 697211 Fax: +39(0371) 697219 URL <http://www.makino.it>

Makino s.r.o.

Tuhovská 31, 83106 Bratislava, Slovakia
Tel: +421 2 496 12 100 Fax: +421 2 496 12 400 URL <http://www.makino.sk>

Makino-CNC Ileri Teknoloji ve Pazarlama Limited Sirketi

Istanbul Trakya Serbest Bolgesi Ataturk Bulvari Begonya Sok.
Blok:1 34540 Catalca / Istanbul / TURKEY
Tel: +90(0)212-7866200 Fax: +90(0)212-7866205

Makino Asia Pte Ltd

2 Gul Avenue, Singapore 629649
Tel: +65-6861-5722 Fax: +65-6861-1600 URL <http://www.makino.com.sg>

Makino India Private Limited

No.11, Export Promotion Industrial Park K.R. Puram, Bangalore - 560 066 India
Tel: +91(0)80-2841- 9500 Fax: +91(0)80-2841-0538 URL <http://www.makinoindia.co.in>

Makino Thailand Co., Ltd.

57/23 Moo 4, Ramintra Road, km 2.5, Bangkhen, Bangkok 10220 Thailand
Tel: +66(0)2971-5750 Fax: +66(0)2971-5751 URL <http://www.makino.com.th>

Makino China Co., Ltd.

No.2 Makino Rd, Jiangsu Mould Industry Experimental Zone,
Kunshan National Hi-Tech Industrial Park, Kunshan, Jiangsu Province. PRC
Tel: +86(0)512-5777-8000 Fax: +86(0)512-5777-9900 URL <http://www.makino.com.cn>

Makino Milling Machine Co., Ltd. Seoul Branch

335-12, Dokusan-Dong, Geumcheon-Gu, Seoul, Korea
Tel: +82(0)2-856-8686 Fax: +82(0)2-856-8555 URL <http://www.makinoseoul.co.kr>



*The specifications in this catalog may be changed without prior notice to incorporate improvements resulting from ongoing R&D programs.

*The machines displayed in this catalog are fitted with optional equipment.

*This product, including technical data and software, may be subject to the Japanese Foreign Exchange and Foreign Trade Law.
Prior to any re-sale, re-transfer or re-export of controlled items, please contact Makino to obtain any required authorization or approval.

*All machining results in this brochure are based on conditions which is designated by Makino.

Machine Specifications

		DUO43	DUO64
Travels (X × Y × Z axes)	mm	450 × 300 × 320	650 × 400 × 420
Travels (U × V axes)	mm	± 101 × ± 101 (with limitation)	←
Table working area (Square)	mm	710 × 560	910 × 660
Maximum workpiece size	mm	710 × 560 × 300	910 × 660 × 400
Maximum dielectric fluid height	mm	365	465
Maximum workpiece weight	kg	800	1200
Height to table surface	mm	1000	←
Wire electrode diameter	mm	φ 0.1, φ 0.15, φ 0.2, φ 0.25, φ 0.3	←
Maximum taper angle		± 15° / 100 mm *1	←
Dielectric fluid tank capacity	L	700	990
Deionizing resin		20-liter pack	←
Dielectric fluid filters		4	←
Machine dimensions (W × D)	mm	1975 × 2815	2200 × 3140
Machine height (h)	mm	2250 *2	2422
Floor space (W × D)	mm	2920 × 3905	3100 × 4440
Machine weight	kg	5000	6000

*1 In the case of PICO precision guide system, MEGACUT-A wire is required for taper machining larger than 10°. And Machinable taper angle larger than 2° is limited according to jet nozzle diameter.

*2 When opening filter case door, Machine height is 2411 mm.

MGW-S6 Power Supply Unit

Item	Specification
Circuit type	Transistor pulse circuit
Maximum machining current	30 A
Current settings	128 levels
Voltage settings	35 levels
OFF intervals	256 levels
Automatic voltage regulator	Standard
Cooling system	Forced air cooling
LL generator circuit	Standard

Jet nozzle diameter and start hole diameter (for machining with nozzle contact)

Plate thickness (mm)	Start hole diameter (mm)											
	0.4	0.5	0.6	0.7	0.8	0.9	1.0	1.1	1.2	1.3	1.4~	
0 ~ 30												
0 ~ 50												
0 ~ 100												

0.5 mm dia. jet 0.7 mm dia. jet
1.0 mm dia. jet 1.5 mm dia. jet

Standard Specifications

- Submerged machining specification
- Split precision guide system
- Square shape table
- Automatic water level setting
- Automatic wire threading unit
- Fine-hole automatic wire threading unit
- Standard needle (φ 2 mm)
- Dielectric fluid cooling unit
- Work light
- Automatic power failure recovery
- Power supply line filter
- Portable multifunction control panel FPB2
- Track ball type mouse
- Ethernet 10 / 100BASE-TX
- USB flash memory interface
- Part program storage length 1000 m
- H.E.A.T. (Only Split precision guide system)

Optional Specifications * ◆ Optional Equipment

Machine

- PICO precision guide system (including jet nozzle φ 1 mm)
- 0.05 μm scale feedback (X, Y axes or X, Y, U, V axes)
- NC index unit
- Workpiece air blower for rust prevention
- Special customer-specified machine colors
- ◆ Large-capacity wire reel loader (20 kg, 30 kg)
- ◆ Jet nozzle (φ 0.5, 0.7, 1.5 mm) (Only PICO precision guide system)
- ◆ Cartridge-type deionizing resin
- ◆ Workpiece clamp set
- ◆ Workpiece support
- ◆ Automatic water supply unit
- ◆ Workpiece washing gun
- ◆ Angle cut set (Only φ 0.2, 0.25 mm wire with Split precision guide system)
- ◆ Maintenance set
- ◆ Standard supplies set (running kit)

Control System

- ◆ Alarm signal tower (1, 2 or 3 lamps)
- ◆ Program master
- ◆ Additional part program storage (total 1000 + 2000 = 3000 m)
- ◆ Circuit breaker
- ◆ RS232C interface

* Optional specifications are not retrofittable.

**Specifications may differ according to area, please contact your nearest Makino sales representative for details.

DUO43

Front view

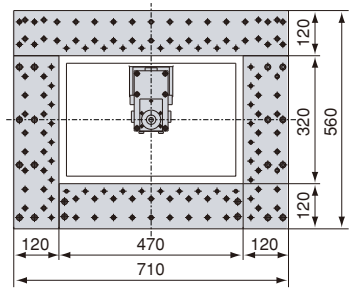
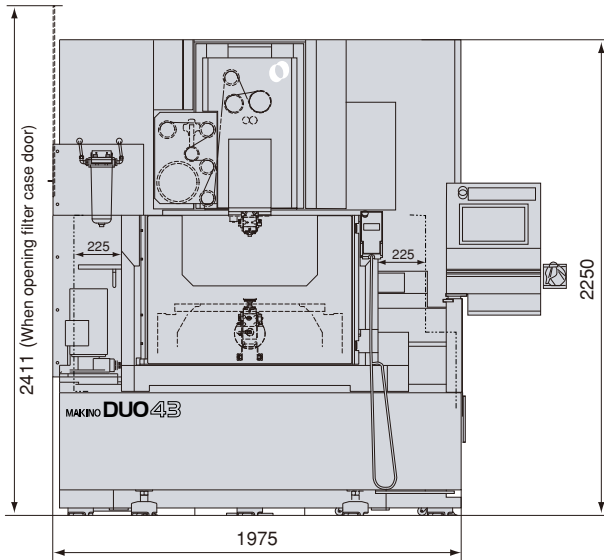

Table

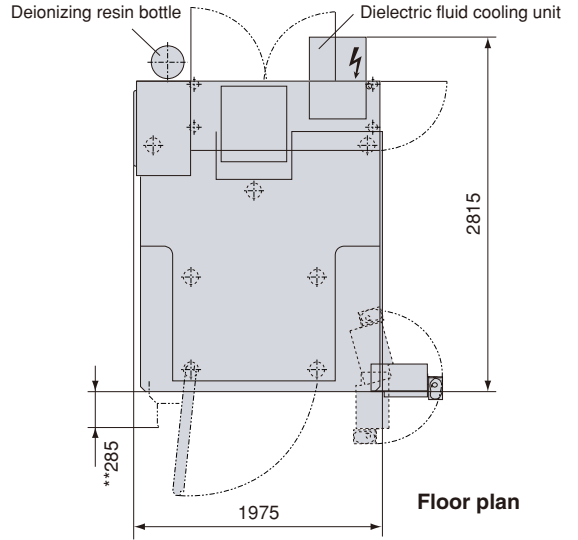

Floor plan

DUO64

Front view

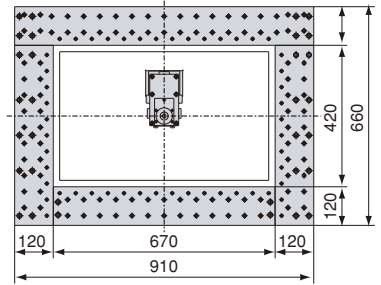
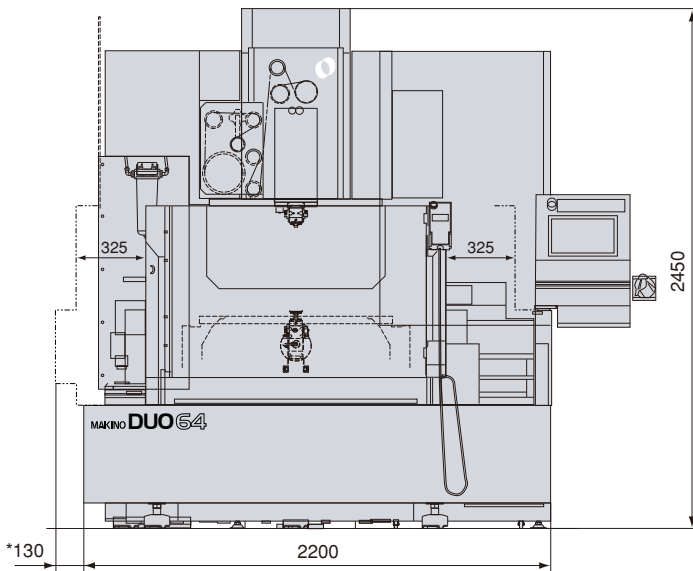

Table

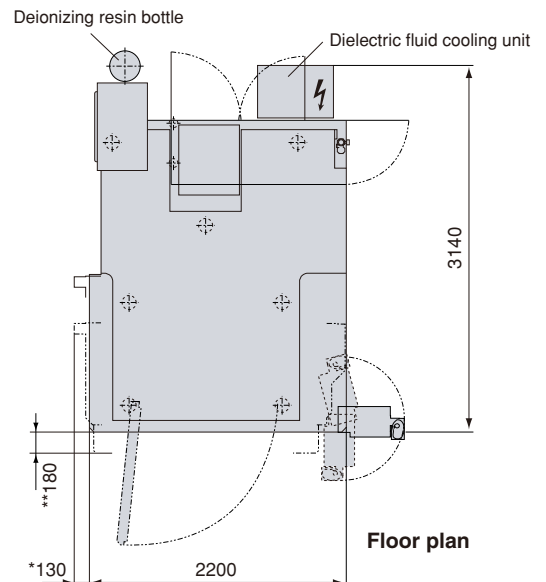

Floor plan

* Work tank position at X axis stroke end

** Work tank position at Y axis stroke end