

ROUND0

3-Roll Plate Bending Machines

Type PS

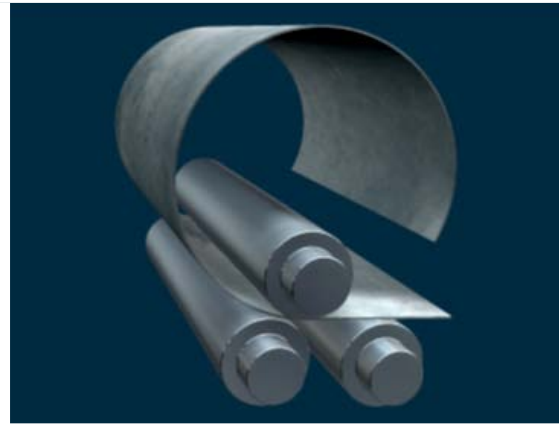

Universal Machine used for all Plate Bending Double Pinch Design

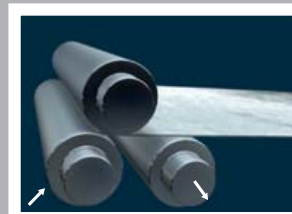

1. Align the plate using the alignment grooves in the lower rolls or against the rear roll. The prebending is accomplished by clamping the plate between the top roll and one of the lower rolls. The other lower roll is in a lower position.



PS 360



PS 310

ROUND O is the world's leading manufacturer of plate and section bending machines. The company was formed in 1964, and has since delivered more than 16 000 machines to satisfied customers around the globe. ROUND O machines are world-renowned for outstanding performance, reliability and quality.

Wide Range of Machines

The standard range of 3-roll plate bending machines covers plate thicknesses from 3 mm (1/8") to 100 mm (4") and widths from 1 000 mm to 8 000 mm (3' to 26'). All machines have unique features needed for high precision and versatility:

- **Prebending of both the leading and trailing edge.** In many cases, the remaining flat end is as short as one time the plate thickness.
- **Fully hydraulic, infinitely variable speed drive and adjustment of the rolls.**
- **Highest drive torque of any comparable machine.**
- **Frames made of high-strength steel, welded and fully stress relieved before machining to have sufficient strength to absorb bending forces and to achieve highest possible accuracy.**
- **All purpose machine with wide working range.**
- **Excellent for cone bending.**

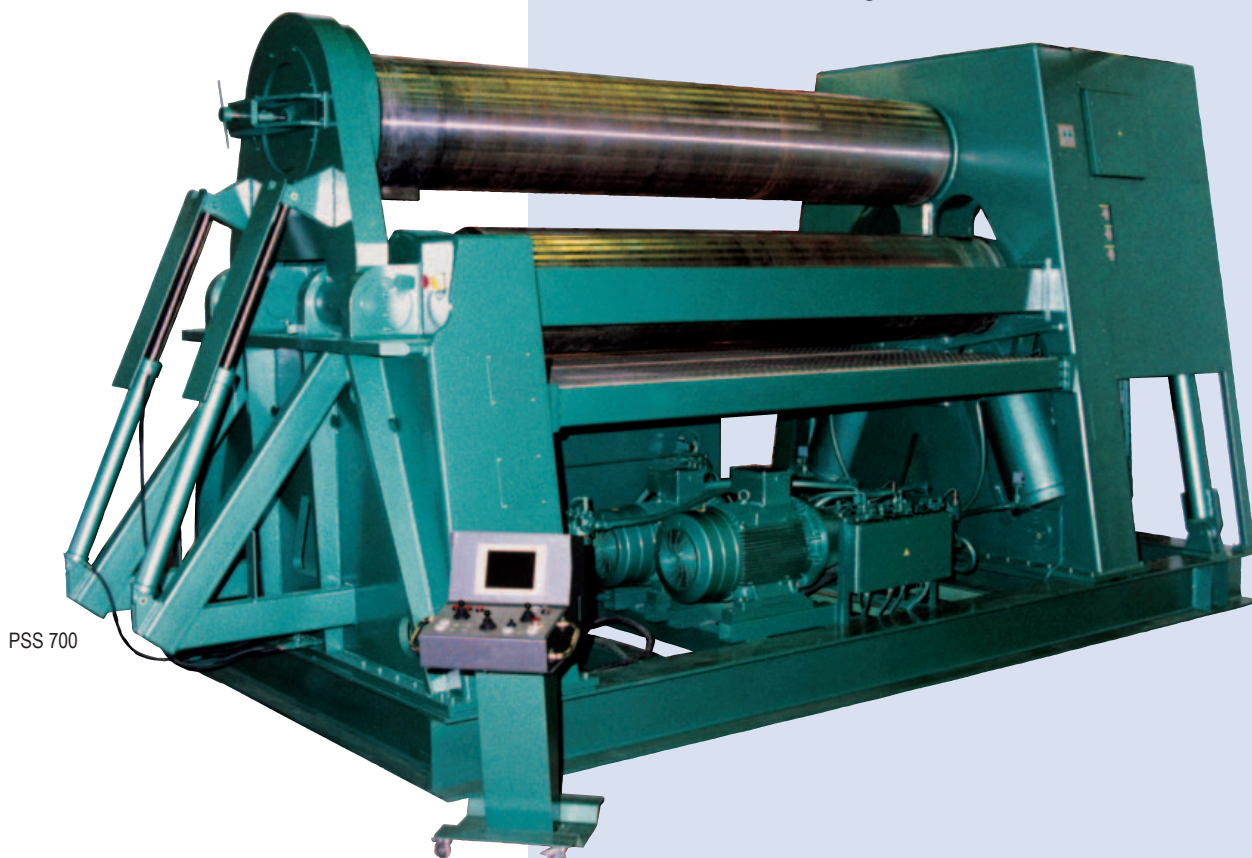

PSS 700



2. The plate is bent towards the top roll by the other roll; and the plate edge is prebent to minimum flat end possible. A length of the plate is rolled and radius is checked.

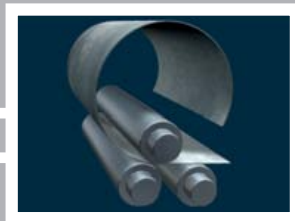

3. Roll the plate through the machine and bend to desired diameter.



4. Lower the clamping roll and raise the other roll until the plate is clamped again. Roll the plate into a closed cylinder and prebend the second plate edge.

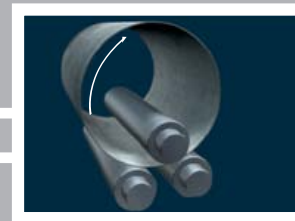

5. Finished cylinder is released from the machine by lowering the drop end.

Most Versatile Plate Roll

The ROUND0 PS machines are the most versatile yet cost-effective bending rolls available today. The pinch/pyramid design provides excellent prebending capabilities of both ends of the plate without the need to remove, turn, and re-insert the plate. Yet, by positioning the rolls in the pyramid (symmetric) configuration, maximum bending capacity can be obtained, as well as maximum cone bending capabilities. The ROUND0 PS machines provide a large opening between the upper and lower rolls, permitting heavy bars and even such unusual items as stair stringers for spiral staircases to be rolled. Versatility can be further expanded by the addition of attachments to roll bar on edge; and, on many models, angle iron, T-bar, channel, pipe and other sections.

Heaviest Frame Components

The main frame on all ROUND0 PS machines is welded steel construction, machined and line bored using the heaviest components of any competitive machine for added strength and rigidity. ROUND0 is the only manufacturer who stress-relieves every frame after welding.

Largest Rolls & Roll Shaft Bearings

The rolls are made from high carbon-content steel forgings for maximum surface hardness and are the largest diameter rolls of any comparable machine. To achieve optimum bending results, the rolls are crowned in a special manner to compensate for the deflection under load. The amount of crowning is calculated by computer to achieve the largest possible thickness range. The rolls are journalled in oversized SKF roller bearings for greatest efficiency and long life.

PS 310

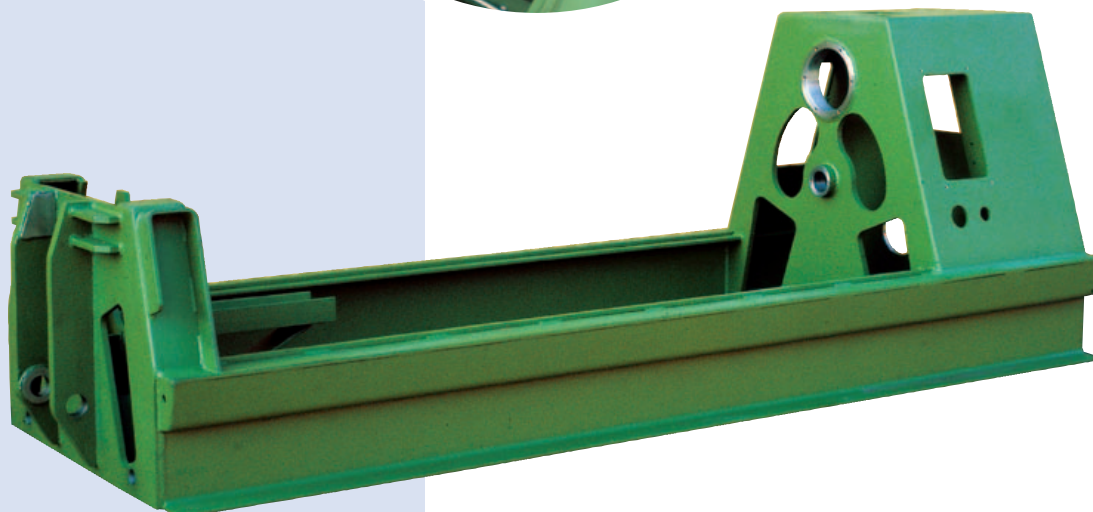



Single hydraulic motor



PS 500

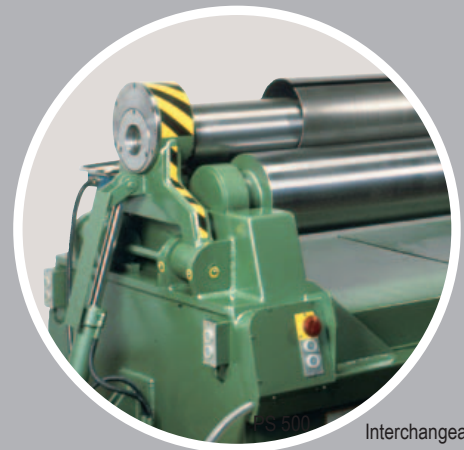

Interchangeable top roll

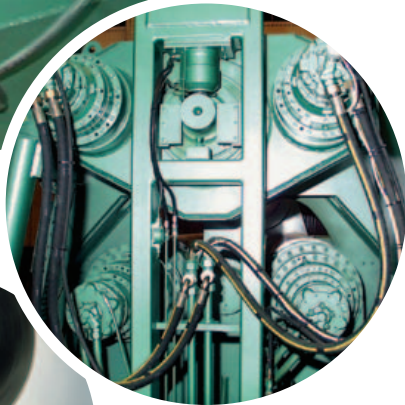

Separate hydraulic motors



Drop end



Highest Drive Torque

ROUND0 PS machines provide the greatest drive torque of any comparable machine. Greater drive torque means the plate can generally be rolled in fewer passes to a tighter diameter. All three rolls are driven at all times. Smaller models incorporate a central hydraulic motor, and larger machines have separate hydraulic motors for each roll. Electronically controlled infinitely variable rolling speeds give the operator full control of the bending process, and are standard on every ROUND0 PS machine.

Greatest Bending Roll Force

The two lower rolls are individually adjusted by hydraulic cylinders at both ends of the rolls. These are sized to allow ROUND0 PS machines to generate more bending power than any comparable machine. Parallelism of the rolls is one of the most crucial factors in achieving good bending results. This is assured on all ROUND0 PS machines, even under maximum load, by the use of series connected cylinders on smaller machines and digital controls on larger machines. In addition, the lower rolls, and optionally even the top roll, can be tilted to facilitate the widest cone rolling capacity.

Massive Drop End

The drop end, or end yoke, is very heavily proportioned and hinged at two swiveling points placed so that they counteract the forces from the lower rolls against the top roll. This construction eliminates any tendency for the drop end to twist.

User-Friendly Controls

Portable controls are utilized as operating controls on the various models. They are designed and arranged to enable the operator to stand at the position best suited for viewing and safety during rolling. Electronic digital readouts or dial indicators are provided to facilitate repetitive rolling operations.

Tilting the rolls for cone rolling is accomplished by push button controls.

Excellent for Cone Bending

The cone bending attachment is mounted on the upper roll at the drop end and is used to slow the small end of the pre-cut cone plate, giving it a lower speed than the large end as they move through the machine. With this attachment and standard power tilting of the lower rolls, cone bending is greatly facilitated. To further enhance cone bending, the machine can be optionally equipped with a tiltable top roll.



Portable control

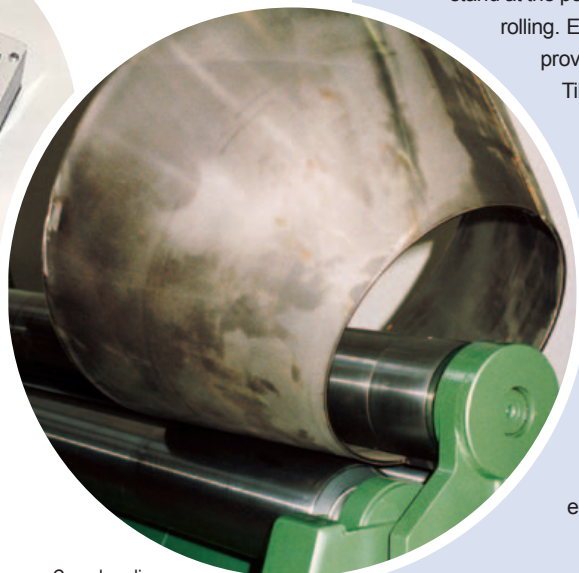

Cone bending

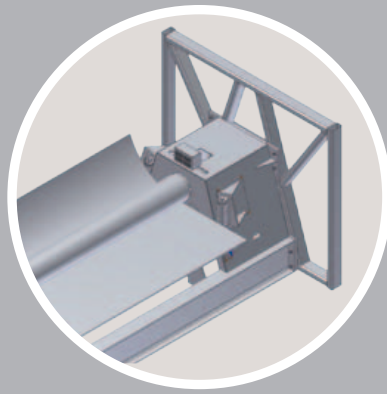
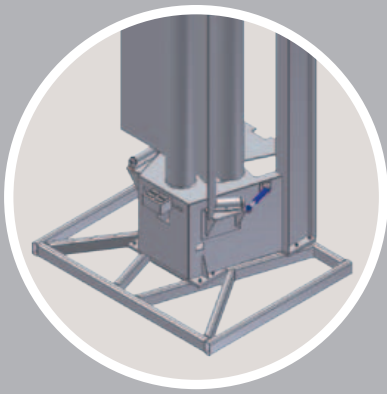

Combined horizontal/vertical design

Side support and overhead support



Optional Equipment

ROUND0 PS machines are the best equipped and most versatile in the industry, yet there are applications where the addition of options such as material handling equipment, bar bending attachments, special top rolls, or special controls such as ROUND0's exclusive PSR/wCNC² are called for. For those applications, we offer the following:

Interchangeable Top Roll

When rolling parts to diameters smaller than the standard top roll will permit, an interchangeable top roll may be installed. This smaller diameter top roll can be easily exchanged with the standard top roll, further enhancing the machine's versatility. Interchangeable top rolls with special crowning or special machining to accommodate unusual applications can also be installed.

Overhead and Side Supports

All PS machines can be equipped with hydraulically operated side supports on one or both sides to support the material as it enters or leaves the machine. An adjustable top support to support the material from overhead helps reduce deformation of the rolled plate. These supports can be ordered mounted on the machine when shipped from the ROUND0 factory, or added later as requirements warrant. This flexibility allows the machine to be equipped in a manner that enhances efficiency, safety and productivity.



Support rolls under the lower roll for long machines

Hardened, Ground and Polished Rolls

For stainless steels and other materials with high strength limits, or when frequent cone bending is anticipated, hardened and ground rolls are recommended. To avoid cracking and warping issues, the rolls are hardened using the preferred 7-step surface hardening process, followed by precision grinding and polishing.

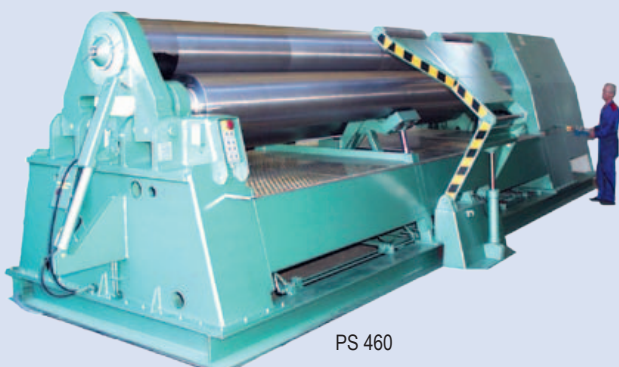

PS 460



PSS 960

Controls



RLC/3 logic control



PSR/wCNC² control



Portable control console

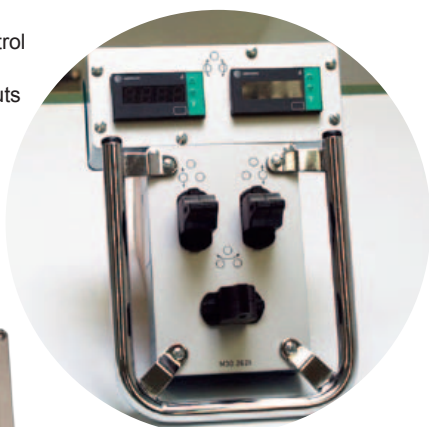

Portable control console with digital readouts



Portable control console with double digital readouts

ROUND O 3-Roll Plate Bending Machines Type PSE and PSS

ROUND O also produces a range of smaller 3-Roll machines, type PSE.

Type PSS is our range of massive capacity 3-Roll machines with separate hydraulic motors and roll diameters up to 1000 mm (40").

Please contact us for detailed information.



PSE 110 x 1000

ROUND O CNC Controls

The ROUND O PSR/wCNC² Control is a PC-based CNC control running on Microsoft® Windows, providing an operator-friendly graphical interface. This highly advanced and powerful system can control an unlimited number of axes, including the main bending rolls, the powered support devices, and even infeed and outfeed devices. Smooth blending of radii by simultaneous rotation and roll adjustment greatly improves the quality of all parts with multiple radii.

The ROUND O PSR/wCNC² Control software includes a library of bending wizards to rapidly produce good parts. Even short runs can be efficiently rolled using this system. The CNC Control is available for all models.

ROUND O PLC Controls

The ROUND O RLC/3 Logic Control System is a PLC based control system designed and developed especially for small plate and section bending machines. This system can control up to 7 axes and the possibility to use USB memory allows an infinite number of bending programs. Optionally, three of these axes can be positioned simultaneously, providing an interpolation function. Programming may be done via integrated keyboard or with fast teach-in function.

Other Control options

The ROUND O RLC/1 Position Control System is a basic positioning control with 2 pre-set values for each axis (one for up and one for down). The positioning control automatically stops the movement of the bending roll when the preset value is reached. This system is designed to make repetitive bends, eliminating the need to manually stop at all required positions.

Electronic Digital Readouts

The digital readout is in place of the standard dial indicators. They are mounted in the portable control station and are available for all models to improve the positioning accuracy of the bending rolls when adjusted by the operator. To further enhance productivity, especially for cone rolling, double digital readouts showing the positions of each end of each lower roll are available.



Capacities and Specifications

ROUND Plate Bending Machines Type PS

| Machine size | Prebending capacity | Rolling capacity down to bending diameter: | | | Diameter of top roll | ITR Min. Ø | | Motor | Net weight | | Gross weight |
|--------------|---------------------|--|----------------|----------------|----------------------|------------|-----|-------|------------|--|--------------|
| | | 3 x top roll Ø | 5 x top roll Ø | 3000 - 5000 mm | | 1) | 2) | | 2) | | |
| | mm | mm | mm | mm | mm | mm | kW | tons | tons | | |
| 205 | 1500 x 6 | 1500 x 10 | 1500 x 12 | 1500 x 14 | 205 | 140 | 4 | 3,2 | 3,6 | | |
| 230 | 1500 x 8 | 1500 x 13 | 1500 x 15 | 1500 x 17 | 230 | 180 | 5,5 | 4,6 | 5,1 | | |
| 255 | 1500 x 10 | 1500 x 16 | 1500 x 18 | 1500 x 19 | 255 | 170 | 5,5 | 4,9 | 5,4 | | |
| 280 | 1500 x 12 | 1500 x 20 | 1500 x 22 | 1500 x 23 | 280 | 190 | 7,5 | 6,3 | 6,9 | | |
| 310 | 1500 x 14 | 1500 x 23 | 1500 x 25 | 1500 x 27 | 310 | 220 | 11 | 6,8 | 7,4 | | |
| 340 | 1500 x 20 | 1500 x 26 | 1500 x 29 | 1500 x 32 | 340 | 240 | 22 | 11,1 | 11,8 | | |
| 360 | 1500 x 26 | 1500 x 30 | 1500 x 34 | 1500 x 38 | 360 | 260 | 22 | 12,3 | 13,1 | | |
| 390 | 1500 x 32 | 1500 x 37 | 1500 x 44 | 1500 x 46 | 390 | 300 | 30 | 14,4 | 15,3 | | |
| 460 | 1500 x 38 | 1500 x 46 | 1500 x 54 | 1500 x 56 | 460 | 370 | 37 | 24,0 | 25,2 | | |
| 500 | 1500 x 45 | 1500 x 53 | 1500 x 62 | 1500 x 65 | 500 | 420 | 50 | 29,8 | 31,3 | | |
| 550 | 1500 x 51 | 1500 x 68 | 1500 x 80 | 1500 x 85 | 550 | 460 | 60 | 35,0 | 36,8 | | |
| 600 | 1500 x 66 | 1500 x 78 | 1500 x 93 | 1500 x 96 | 600 | 500 | 75 | 42,0 | 44,0 | | |
| 205 | 2000 x 6 | 2000 x 9 | 2000 x 11 | 2000 x 13 | 205 | 140 | 4 | 3,5 | 4,0 | | |
| 230 | 2000 x 8 | 2000 x 13 | 2000 x 15 | 2000 x 17 | 230 | 180 | 5,5 | 5,1 | 5,7 | | |
| 255 | 2000 x 10 | 2000 x 15 | 2000 x 17 | 2000 x 18 | 255 | 170 | 5,5 | 5,6 | 6,1 | | |
| 280 | 2000 x 12 | 2000 x 18 | 2000 x 19 | 2000 x 20 | 280 | 190 | 7,5 | 7,1 | 7,7 | | |
| 310 | 2000 x 14 | 2000 x 20 | 2000 x 22 | 2000 x 24 | 310 | 220 | 11 | 7,8 | 8,4 | | |
| 340 | 2000 x 18 | 2000 x 22 | 2000 x 26 | 2000 x 28 | 340 | 240 | 22 | 12,2 | 12,9 | | |
| 360 | 2000 x 22 | 2000 x 28 | 2000 x 33 | 2000 x 35 | 360 | 260 | 22 | 13,5 | 14,3 | | |
| 390 | 2000 x 28 | 2000 x 32 | 2000 x 37 | 2000 x 40 | 390 | 300 | 30 | 16,0 | 17,0 | | |
| 460 | 2000 x 32 | 2000 x 41 | 2000 x 48 | 2000 x 51 | 460 | 370 | 37 | 26,0 | 27,3 | | |
| 500 | 2000 x 40 | 2000 x 46 | 2000 x 55 | 2000 x 57 | 500 | 420 | 50 | 32,2 | 33,8 | | |
| 550 | 2000 x 45 | 2000 x 60 | 2000 x 70 | 2000 x 73 | 550 | 460 | 60 | 38,0 | 40,0 | | |
| 600 | 2000 x 53 | 2000 x 68 | 2000 x 80 | 2000 x 83 | 600 | 500 | 75 | 45,6 | 47,8 | | |
| 205 | 2500 x 5 | 2500 x 8 | 2500 x 10 | 2500 x 11 | 205 | 140 | 4 | 4,1 | 4,6 | | |
| 230 | 2500 x 6 | 2500 x 12 | 2500 x 14 | 2500 x 16 | 230 | 180 | 5,5 | 5,7 | 6,3 | | |
| 255 | 2500 x 8 | 2500 x 14 | 2500 x 15 | 2500 x 17 | 255 | 170 | 5,5 | 6,2 | 6,8 | | |
| 280 | 2500 x 10 | 2500 x 16 | 2500 x 17 | 2500 x 18 | 280 | 190 | 7,5 | 7,9 | 8,6 | | |
| 310 | 2500 x 12 | 2500 x 18 | 2500 x 20 | 2500 x 22 | 310 | 220 | 11 | 9,8 | 10,5 | | |
| 340 | 2500 x 15 | 2500 x 20 | 2500 x 23 | 2500 x 25 | 340 | 240 | 22 | 13,3 | 14,1 | | |
| 360 | 2500 x 20 | 2500 x 26 | 2500 x 30 | 2500 x 33 | 360 | 260 | 22 | 14,8 | 15,7 | | |
| 390 | 2500 x 25 | 2500 x 30 | 2500 x 34 | 2500 x 36 | 390 | 300 | 30 | 17,8 | 19,0 | | |
| 460 | 2500 x 30 | 2500 x 36 | 2500 x 43 | 2500 x 45 | 460 | 370 | 37 | 28,0 | 29,4 | | |
| 500 | 2500 x 35 | 2500 x 42 | 2500 x 50 | 2500 x 52 | 500 | 420 | 50 | 34,6 | 36,3 | | |
| 550 | 2500 x 40 | 2500 x 53 | 2500 x 62 | 2500 x 65 | 550 | 460 | 60 | 41,6 | 43,8 | | |
| 600 | 2500 x 50 | 2500 x 60 | 2500 x 72 | 2500 x 74 | 600 | 500 | 75 | 49,0 | 51,3 | | |
| 205 | 3000 x 4 | 3000 x 7 | 3000 x 8 | 3000 x 10 | 205 | 140 | 4 | 4,5 | 5,1 | | |
| 230 | 3000 x 5 | 3000 x 8 | 3000 x 10 | 3000 x 11 | 230 | 180 | 5,5 | 6,2 | 6,9 | | |
| 255 | 3000 x 6 | 3000 x 11 | 3000 x 12 | 3000 x 14 | 255 | 170 | 5,5 | 7,0 | 7,7 | | |
| 280 | 3000 x 8 | 3000 x 13 | 3000 x 15 | 3000 x 16 | 280 | 190 | 7,5 | 8,7 | 9,4 | | |
| 310 | 3000 x 10 | 3000 x 16 | 3000 x 18 | 3000 x 19 | 310 | 220 | 11 | 10,8 | 11,5 | | |
| 340 | 3000 x 12 | 3000 x 18 | 3000 x 21 | 3000 x 23 | 340 | 240 | 22 | 14,5 | 15,3 | | |
| 360 | 3000 x 15 | 3000 x 22 | 3000 x 27 | 3000 x 30 | 360 | 260 | 22 | 16,3 | 17,2 | | |
| 420 | 3000 x 20 | 3000 x 26 | 3000 x 31 | 3000 x 33 | 420 | 270 | 30 | 19,5 | 20,7 | | |
| 460 | 3000 x 25 | 3000 x 33 | 3000 x 40 | 3000 x 41 | 460 | 370 | 37 | 30,0 | 31,5 | | |
| 500 | 3000 x 30 | 3000 x 38 | 3000 x 45 | 3000 x 47 | 500 | 420 | 50 | 37,0 | 38,8 | | |
| 550 | 3000 x 35 | 3000 x 48 | 3000 x 57 | 3000 x 59 | 550 | 460 | 60 | 45,0 | 47,3 | | |
| 600 | 3000 x 45 | 3000 x 55 | 3000 x 65 | 3000 x 67 | 600 | 500 | 75 | 52,5 | 55,0 | | |
| 205 | 3500 x 3 | 3500 x 5 | 3500 x 6 | 3500 x 8 | 205 | 140 | 4 | 5,0 | 5,7 | | |
| 255 | 3500 x 5 | 3500 x 9 | 3500 x 11 | 3500 x 12 | 255 | 170 | 5,5 | 7,7 | 8,4 | | |
| 310 | 3500 x 7 | 3500 x 12 | 3500 x 15 | 3500 x 17 | 310 | 220 | 11 | 11,8 | 12,6 | | |
| 340 | 3500 x 10 | 3500 x 16 | 3500 x 19 | 3500 x 20 | 340 | 240 | 22 | 15,6 | 16,5 | | |
| 360 | 3500 x 12 | 3500 x 20 | 3500 x 25 | 3500 x 28 | 360 | 260 | 22 | 17,6 | 18,6 | | |
| 420 | 3500 x 16 | 3500 x 23 | 3500 x 28 | 3500 x 30 | 420 | 270 | 30 | 21,2 | 22,6 | | |
| 460 | 3500 x 22 | 3500 x 31 | 3500 x 36 | 3500 x 38 | 460 | 370 | 37 | 32,0 | 33,6 | | |
| 500 | 3500 x 27 | 3500 x 35 | 3500 x 42 | 3500 x 44 | 500 | 420 | 50 | 39,4 | 41,3 | | |
| 550 | 3500 x 32 | 3500 x 45 | 3500 x 52 | 3500 x 55 | 550 | 460 | 60 | 48,5 | 51,0 | | |
| 600 | 3500 x 40 | 3500 x 50 | 3500 x 60 | 3500 x 62 | 600 | 500 | 75 | 56,0 | 58,7 | | |

- The capacities are based on normal steel with yield point 270 N/mm² (38 000 psi).
- The minimum bending diameter is 1,1 – 1,4 x the top roll diameter depending on plate thickness.
- Remaining straight end after prebending 1,5 – 2 x plate thickness.
- Other machine lengths can be delivered on request.
- All data subject to change without prior notice.

1) The PS-machines can be equipped with an interchangeable top roll with any diameter between the min. diameter in the table and the standard top roll.

2) Weight for basic machine without optional equipment.

Other Machines from ROUND0



PASS 255

4-Roll Plate Bending Machines

The standard range of 4-roll plate bending machines covers plate thicknesses of 3-100 mm (1/8" to 4") and widths of 1 000-8 000 mm (3' to 26').

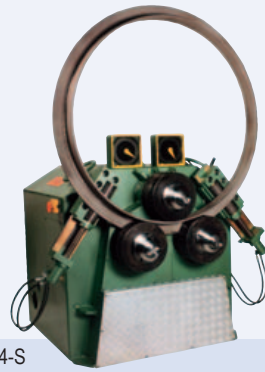

R-4-S

Section Bending Machines

Largest selection of section bending machines on the market, with over 20 standard sizes.

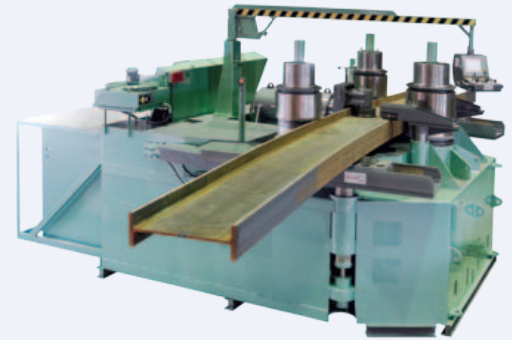

R-16-S

Section Bending Machines

The larger sizes of section bending machines are designed also for bending I, U and H beams the hard way. R-16-S, the world's largest section bending machine, can bend up to HE 1000 (W-44") the hard way.



PM-1

Quick Rolling Machines

Plate bending machines for large production runs of cylinders with cycle times as short as 10 seconds. For plate thicknesses up to 12 mm (1/2") and widths up to about 2 000 mm (6').



SF-2

Flanging and Punching Machines

For flanging and punching cylinders in the same operation. Cylinder diameters of 350-3 000 mm (14" to 120") and plate thicknesses up to 8 mm (5/16").

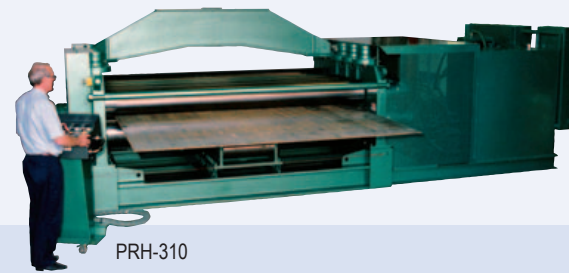

PRH-310

Plate Straightening Machines

Straighten plates with thicknesses of 2-40 mm (0,074" to 1 9/16") and widths up to 4 000 mm (13'). Produced with 5, 7 or 9 rolls depending on tolerance requirement.

ROUND0 also produces: Beambenders, beading and joggling machines, welding positioners and other customized machines.

ROUND0

www.roundo.com

LPI Maskin AB
 Box 171
 SE-281 22 Hässleholm
 Sweden
 Tel: +46 451 422 00
 Fax: +46 451 824 04
info@roundo.com