



**MIKRON
HSM/XSM
400 LP, 400U LP,
500 LP**



MIKRON HSM 400 LP / 500 LP

MIKRON HSM 400U LP

High-speed milling - universal approach to mould-making and production

Contents

Applications		Basic machine	18
3-axis	4	Feed axes	19
5-axis	6	Precision	20
		LP Precision	23
Highlights	8	High-tech spindles	24
		Tool magazine	25
Automation	10	Chip and dust	26
		Option: ProdMod	27
Table versions		Options	28
3-axis	14	smart machine	29
5-axis	15	About GF AgieCharmilles	30

GF AgieCharmilles presents new reference machines in 3-axis and 5-axis versions for high-speed and ultra-highspeed milling.

Based on the concept of the present HSM/XSM series, GF AgieCharmilles engineers have developed three new machine models which represent

optimal answers to all aspects of 3-axis and 5-axis high-speed and ultra-highspeed milling needs. The HSM/XSM LP series (LP = Linear Performance) were designed for ultimate precision and supreme surface quality. The necessary design measures focus on the machine bed, cooling, axis drives, motion control and tool measurement.

These vertical high-speed machining centres, developed for tool and mould manufacturing as well as medium- and small-series production of high-quality parts, combine the Swiss machine manufacturer's entire technical know-how and extensive development experience.

GF AgieCharmilles.



MIKRON XSM 400 LP



MIKRON XSM 400U LP

Ultra-highspeed milling - for our demanding customers

Applications

3-axis

MIKRON HSM 400 LP
 MIKRON XSM 400 LP
 MIKRON HSM 500 LP

Watch components

MIKRON XSM 400 LP

Different materials

Watch making industry/ micro-mechanics

- Shape accuracy
- Smallest geometries
- Parts-specific handling systems



Graphite electrode

MIKRON HSM 400 LP

Graphite

Mold making

- High contour accuracy
- Efficient graphite machining

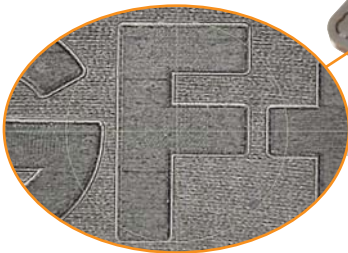

Electrode

MIKRON XSM 400 LP

Tungsten-copper

Tool and mold manufacturing

- High surface quality
- Shape accuracy
- Very small geometry features

Die

MIKRON HSM 500 LP

Alloyed tool steel

Tool and mold making

- Surface quality
- Shape accuracy



Ball screw drive

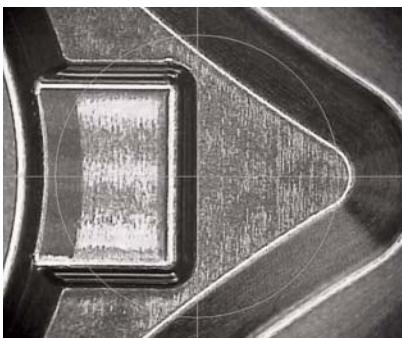

Linear direct drive

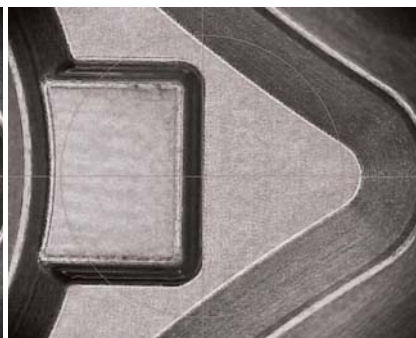

HSC milling of a prototype mould insert





Applications

5-axis

MIKRON HSM 400U LP
MIKRON XSM 400U LP



Watch casing

MIKRON XSM 400U LP

Different materials
Watch making industry

- 5-axis simultaneous machining
- High surface quality



Impeller

MIKRON HSM 400U LP

Aluminium
Automobile industry

- 5-axis simultaneous machining
- High speed
- Thin-walled geometries

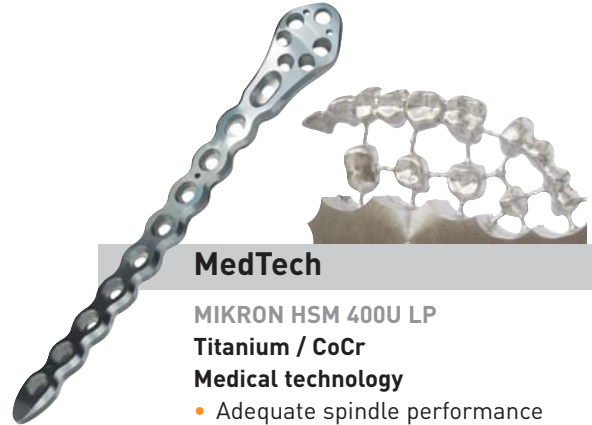

MedTech

MIKRON HSM 400U LP

Titanium / CoCr
Medical technology

- Adequate spindle performance
- Machine stability
- 5-axis simultaneous machining
- Forming and positioning precision



Casting mold

MIKRON HSM 400U LP

Alloyed tool steel
Tool and mold making

- High surface quality
- 5-axis simultaneous machining of thread with undercut section

Machining of an injection mould in 5-axis simultaneous operation





Highlights

Precision and quality for tool- and mold-making
as well as accurate part manufacturing



The MIKRON HSM/XSM LP series impresses with the unrivalled accessibility of all machines in the series, regardless of their particular configuration.



Stability and damping

Primary prerequisites for maximum precision and best workpiece surface quality include damping and stability of the components:

- Monolithic design
- Highly stable portal construction
- Machine base of mineral cast with high damping characteristics
- Optimised force distribution within castings

ITM (Intelligent Tool Measurement)

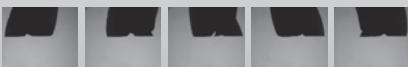

High-speed pictures

ITM tool measurement registers the entire tool tip up to $\varnothing 12$ mm on modern imaging sensors. Special software digitally cleans and measures the digitally captured tool geometry. An idea takes concrete shape: For the first time, ITM makes it possible to measure tools on a MIKRON machine with micrometer-range repeatability.

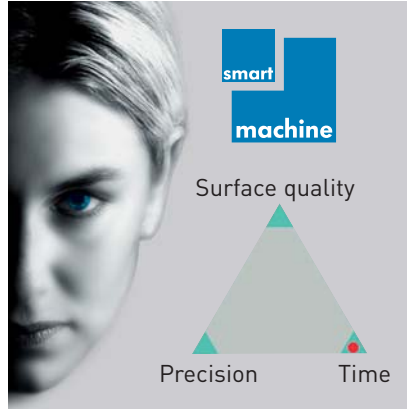

Process optimisation with OSS

The larger a workpiece is, the more it weighs and the more machining time and reworking effort it requires.

The ability to decisively influence the time factor even after CAD/CAM programming is therefore all the more important. The OSS software module offers specially tailored tool control to suit the machining task.

- Precision: Precise path control according to preset requirements
- Speed: Cuts machining time during roughing and pre-finishing
- Surface quality: Reduces reworking requirements after the finishing process

Chip management

Major attention was paid to the chip flow. Steeply inclined chrome steel plates in the workspace promote the fall of chips.

- No chip accumulation
- Easy cleaning
- Flushing system

Direct drive

The direct drives in X, Y, Z, B and C permit direct translatory and rotational motions of the tool centre point (TCP) without rerouting via a mechanical transmission.

- Short setting time
- No oversteering through drive play and elasticity
- High dynamic rigidity of the attitude control
- Independent of slide position

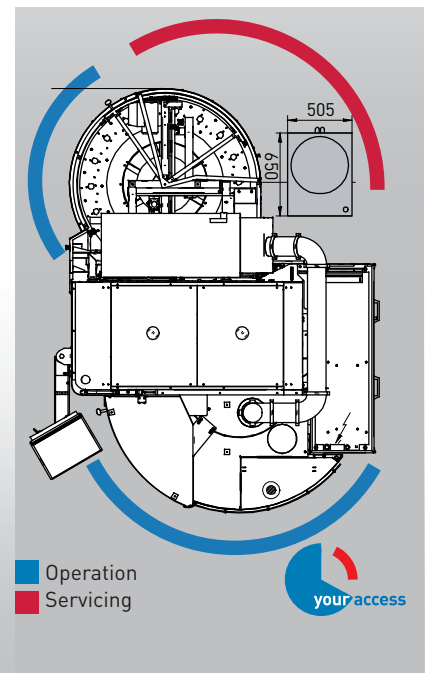

Ergonomics and process reliability

...are key features of this machine series:

- Equally accessible in all upgrade levels - thanks to workpiece automation via the portal
- Excellent view into the workspace
- Access to the workpiece from three sides
- Crane loading
- Side window to optimally monitor machining

Automation with disc type magazine

Producing more parts in shorter time at lower cost

Pallet magazine is a major plus

GF AgieCharmilles has developed its own, fully integrable pallet magazines with customer needs in mind.

The disc magazine can be loaded during operation and the CNC control is very easy to operate.

The automation solution for widely applied industrial standards with a load capacity of up to 90 kg per pallet for the HSM 400 LP and 25 kg for the HSM 400U LP.

Along with the modular tool magazines, this turns the compact milling centre into a highly productive and flexible manufacturing cell.



MIKRON HSM/XSM 400 LP 90 kg System 3R GPS 240 x 240 mm  10x
System 3R Dynafix 280 x 280 mm  7x
Erowa UCP 320 x 320 mm  7x
System 3R Dynafix 350 x 350 mm  7x

MIKRON HSM/XSM 400U LP 25 kg System 3R Macro Magnum  18x
Erowa ITS 148  20x
System 3R Macro  48x



We recommend: SIGMA FMC (Flexible Manufacturing Cell) and RNS (Remote Notification System).

These smart machine modules are the keys to even greater flexibility and process reliability during the production of high-quality components.

Ergonomic charging and uncharging of the disc type magazine during work preparation





Interface for automation systems

Producing more parts
in shorter time at lower cost

A standardised robot interface allows the MIKRON HSM/XSM-LP series to be operated with robot systems from reputable vendors.



Regardless of the handling system used, the accessibility of the machine remains outstanding...



...even when networking with other machines.



The MIKRON HSM 400U LP Robot Integrated.
Loading and unloading takes place from
behind through the portal.





Table versions 3 axis

Process-oriented tool clamping -
the integrated automation interface

MIKRON HSM 500 LP
Up to 200 kg load capacity



Combat unproductive times

Fully integrated zero-point clamping systems are standard equipment on the MIKRON HSM/XSM 400 LP. The machines rely on widely used clamping systems from manufacturers System 3R and Erowa.

MIKRON HSM/XSM 400 LP
Up to 120 kg load capacity

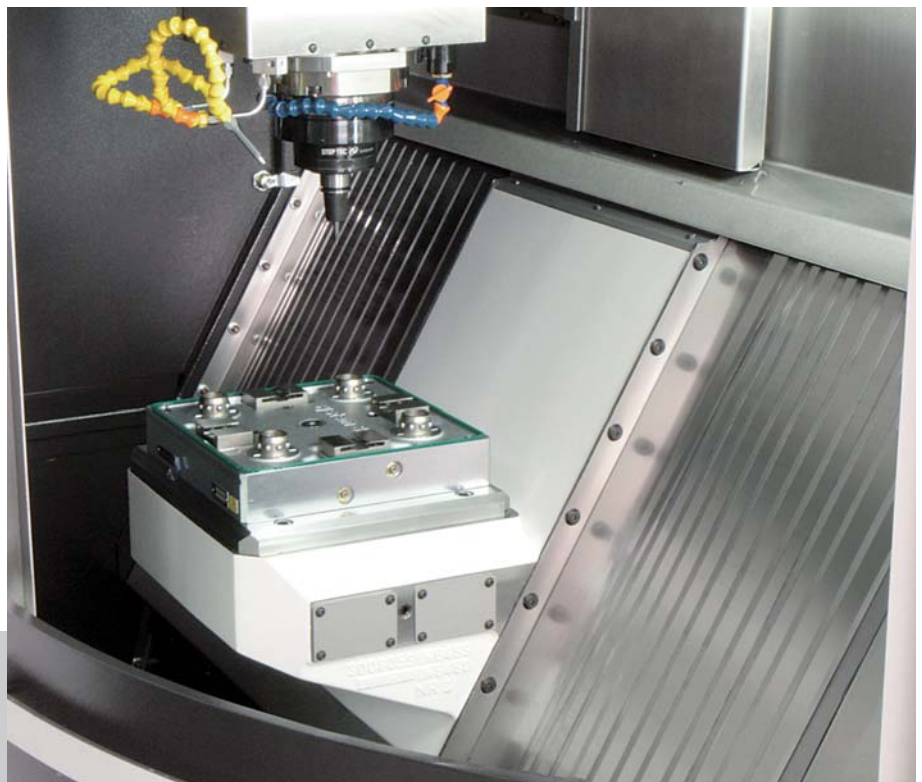
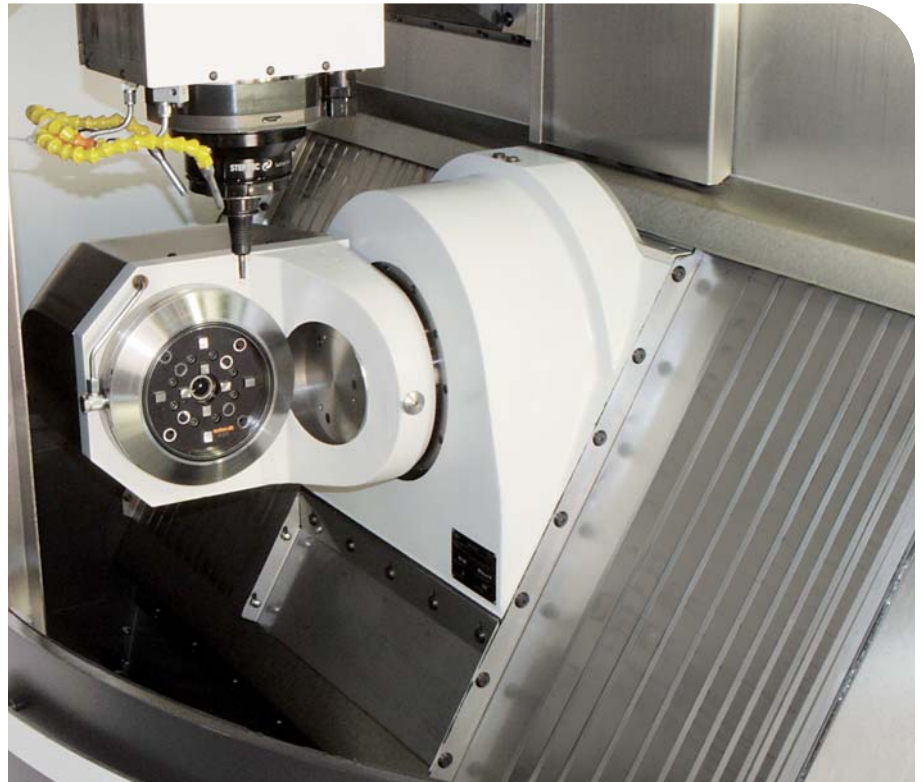

Table versions 5 axis

Speedy results with
HSC simultaneous machining

The excellent dynamics of the circular swivel tables with direct drives in the MIKRON HSM/XSM 400U LP machines achieve genuine HSC simultaneous machining on all 5 axis - another development by GF AgieCharmilles:

- Extremely dynamic and fast: Rotation and swivelling with direct drives in the B and C axis up to 250 min⁻¹
- Extremely accurate and precise: Liquid-cooled motors and absolute measuring systems
- Extremely stable and flexible: hydraulic clamping in the rotation and swivel axis plus integrated zero-point clamping system with a B-axis swivel range of 220°
- Ergonomic and clean: no interfering edges for optimal access and fall of chips



**Circular swivel table
MIKRON HSM/XSM 400U LP.
Up to 25 kg load capacity**

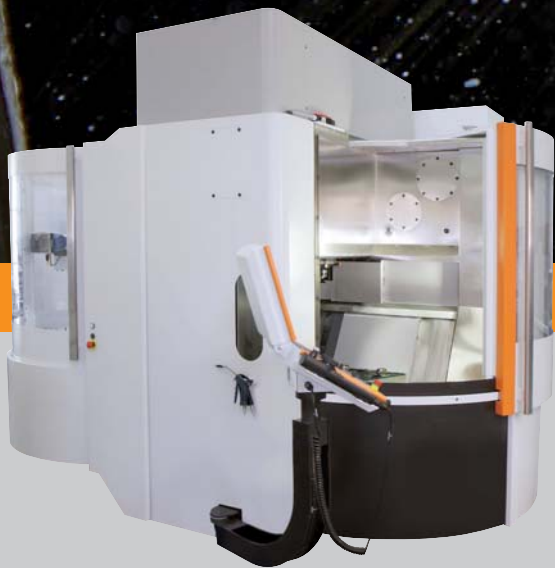

Achieve more...



**MIKRON
HSM/XSM
400 LP, 400U LP,
500 LP**

Basic machine

For uncompromising demands

Polymer-casting machine bed

High rigidity and a compact appearance are attention-getting benefits of the self-contained portal design.

Cross slide

The weight and rigidity of the cross slide are optimised to stand up to the high dynamic requirements.

Polymer concrete

The polymer concrete features high thermal inertia and excellent damping properties. Oils or cooling lubricants are not affected by ageing processes.

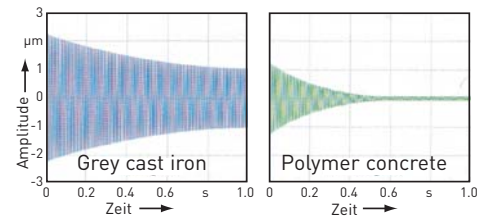
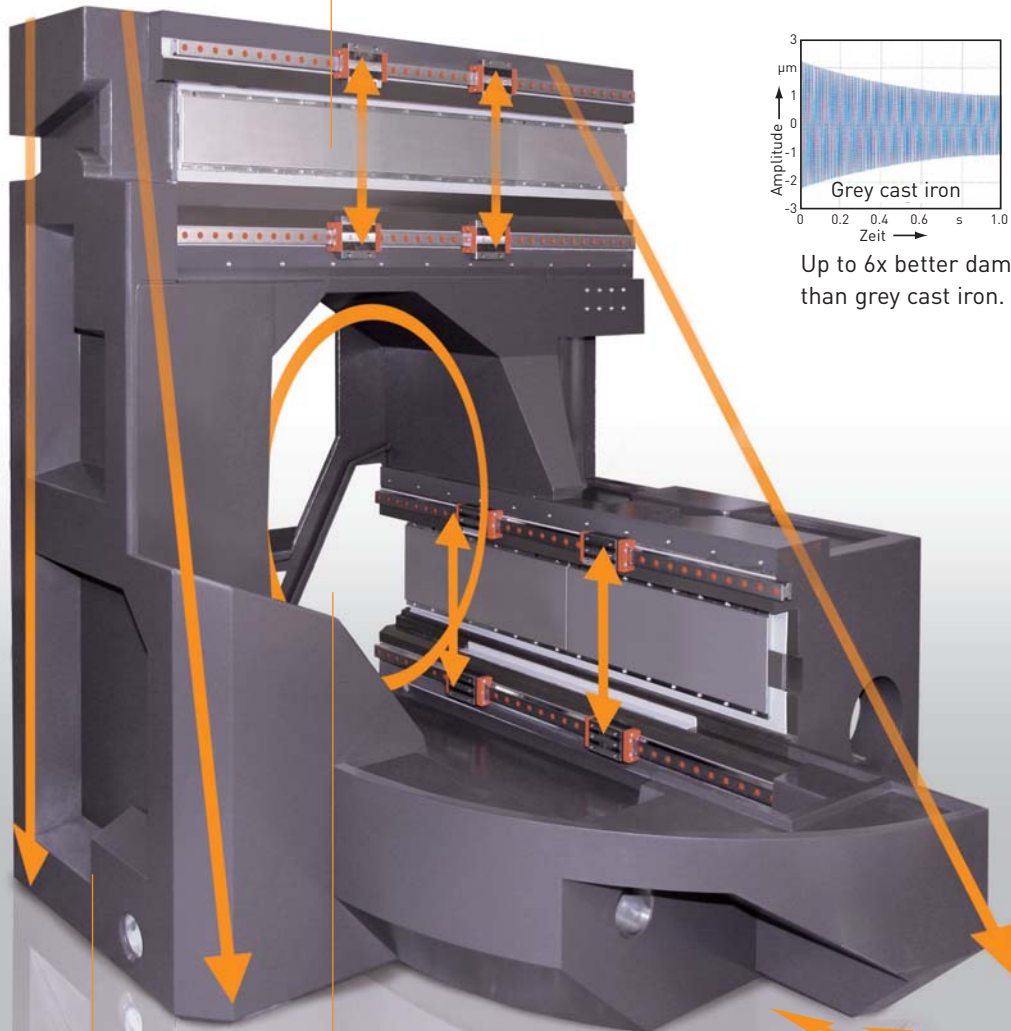

Up to 6x better damping properties than grey cast iron.

Pyramidal configuration

The pyramidal structure ensures optimal weight distribution while stabilising and rigidifying the cutting process.

Closed structure

The O-shaped portal is outstandingly suitable for automation solutions by GF AgieCharmilles or other manufacturers.

Distribution force to the foundation

Because of their unrivaled axial dynamics, machines of the XSM LP series must be connected to three fixed points in the floor foundation.



Dynamics and precision

Mechanical drive systems have a basic disadvantage: a loss of precision must be accepted to achieve a highly dynamic configuration. This effect is not relevant for customers in auxiliary motions such as tool changing or axial positioning. An HSC machine changes the situation: During cutting control, high dynamics must be combined with great precision. This is where the linear direct drive shows all its advantages.

- Short setting time
- No oversteering through drive play and elasticity
- High dynamic rigidity of the attitude control
- Independent of slide position

Advantages

- Outstandingly precise, accurate workpiece machining due to the extremely rigid drive and control concept.
- Excellent long-term precision due to the reduction of friction-induced wear by the direct drive and central oil lubrication
- Reduction of main operating times due to extremely high dynamic parameterisation (OSS)
- Reduction of auxiliary times by high rapid-traverse speeds
- Reduction of maintenance and servicing, since the lack of ball screw drives or transmissions reduces the number of wearing parts.

Central oil lubrication

Linear direct drive



Precision

HSC core components: Static and dynamic precision

Static precision

Swiss thoroughness

Before delivery, every MIKRON HSM/XSM LP machine undergoes an extensive quality check in our air-conditioned assembly hall in accordance with GF AgieCharmilles acceptance guidelines. Quality-consciousness means added value.

Dynamic precision

Path measurement systems

Direct path measurement systems in the linear and rotational axes are standard equipment on all MIKRON HSM/XSM LP machines.

- Tried and tested Heidenhain precision
- Resolution in the nanometer range
- Protected by sealing air

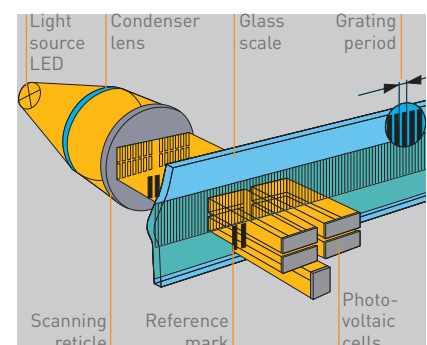
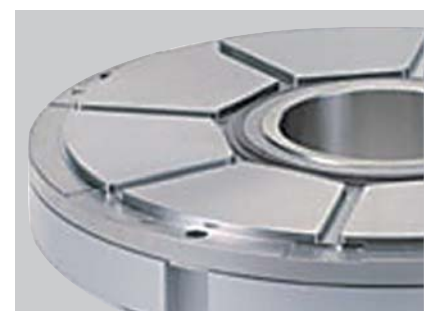

Precision

HSC core components: Thermal precision

Thermal precision

Cooling concept

The MIKRON HSM/XSM LP series ushers in a new era of precision cutting. Since high axis feeds over long periods always heat the drive assemblies, the MIKRON HSM/XSM LP series beats the problem with an ingenious cooling management system. Each of the linear axis as well as the circular swivel unit have their own cooling cycles. The heat is therefore systematically led out of the machine instead of being distributed inside it.

This safeguards geometric stability, which in turn ensures extremely high motion control repeatability.

All electrical heat sources in the MIKRON HSM/XSM LP machines are water-cooled.

- X, Y, Z, B, C drives
- Tool spindle with Opticool technology
- Electrical cabinet



Five separate cooling circuits

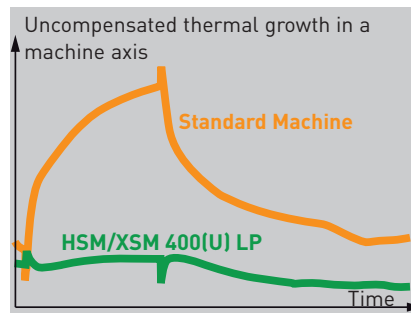

Liquid cooled primary and secondary drive

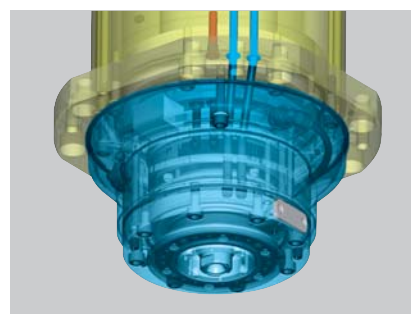

Tool spindle

Even greater precision with Step-Tec Opticool technology

- Cooling of the front roller bearings
- Low thermal flow in the tool interface
- Increases accuracy when working with the measuring probe on the machine

Measuring probe

Even greater precision with new Thermo-Lock measuring probe technology.

- Easy set-up
- Inhibits thermal flow between measuring probe and tool spindle
- Increases accuracy when working with the measuring probe on the machine
- Two strong partners: Thermo-Lock and Opticool

Precision

ITM - the breakthrough in tool measuring



ITM (Intelligent Tool Measurement)

ITM tool measurement registers the entire tool tip up to \varnothing 12 mm on modern imaging sensors. Special software digitally cleans and measures the digitally captured tool geometry. An idea takes concrete shape: For the first time, ITM makes it possible to measure tools on a MIKRON machine with micrometer-range repeatability.

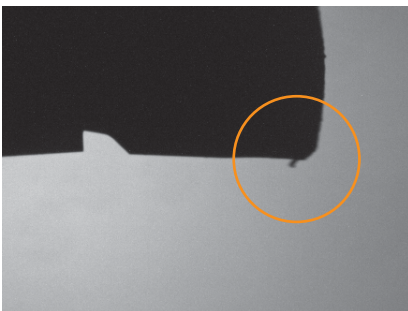

Detection of foreign particles

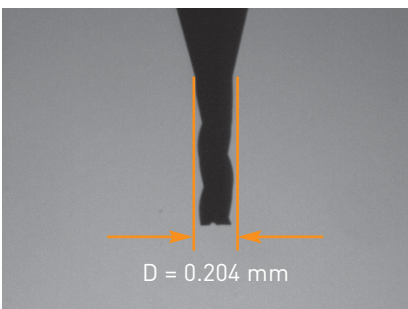

Measurement of smallest tool diameters

Test-piece with continuously increasing Z-level.
 Step by step: $2\ \mu\text{m}$
 Orthogonal cutting to zero point Z-level with intermittent measuring cycle of employed spherical cutting tool.

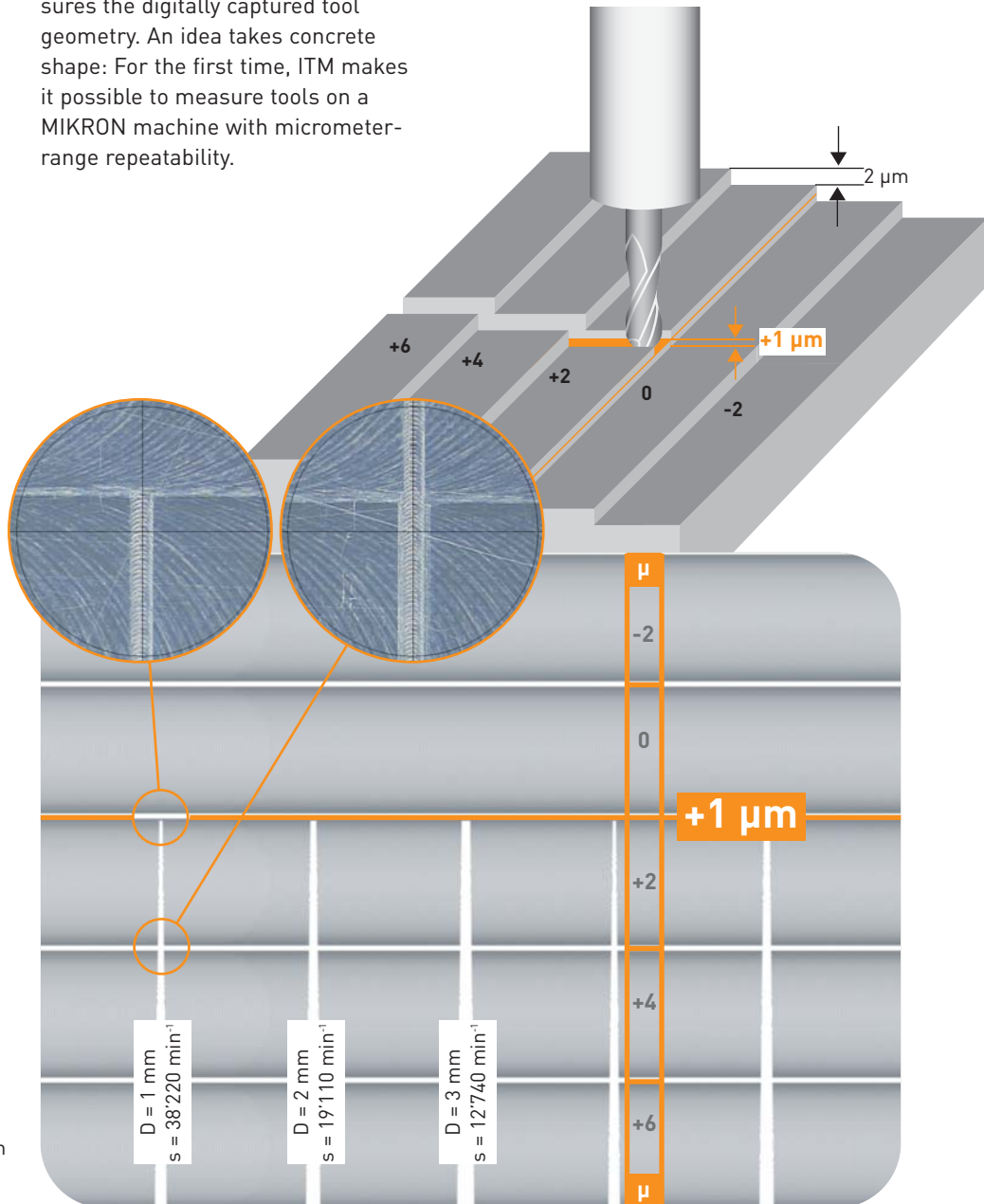

LP Precision

When fractions of a micrometer count...

- Axis construction based on selected machine elements for the highest levels of precision
- The specific smart machine modules OSS Precision and ITC Precision

Despite extremely precise cutting on the work piece the machine still demonstrates full high-speed-cutting characteristics:
 MIKRON HSM 400(U) LP Precision
 MIKRON HSM 500 LP Precision
 with 42 m/min and 0.7 g

Extremely precise machining is possible through highly precise implementation of NC commands (0.1 µm) which manifests itself in the target values 3D dimensional accuracy and optical surface quality.

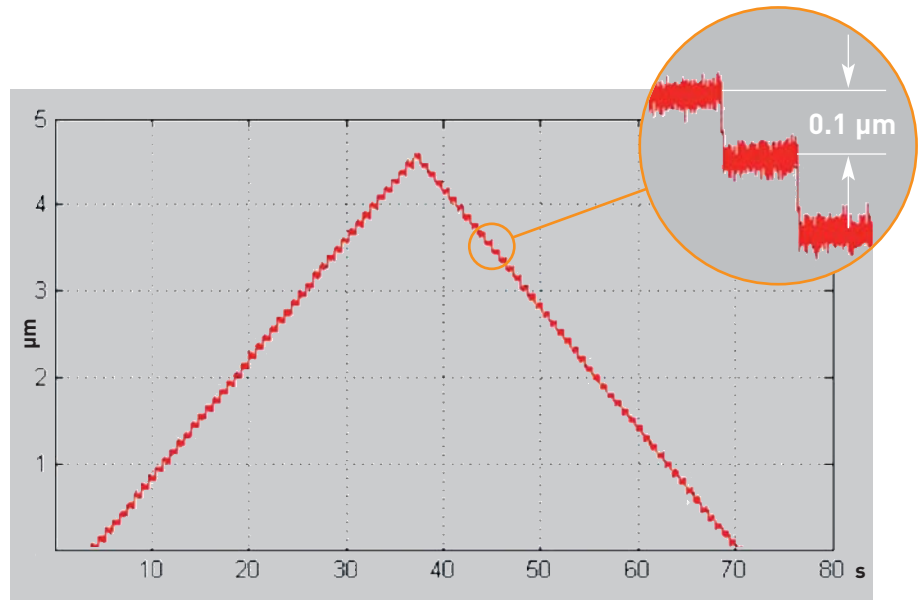

Target value: 3D dimensional accuracy

* The applications shown are just examples. The results can only be achieved under certain process parameters and environmental conditions.

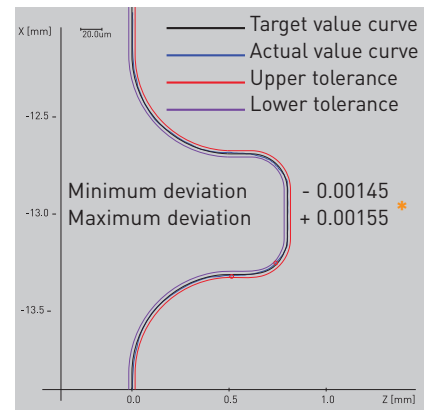

Target value: optical surface

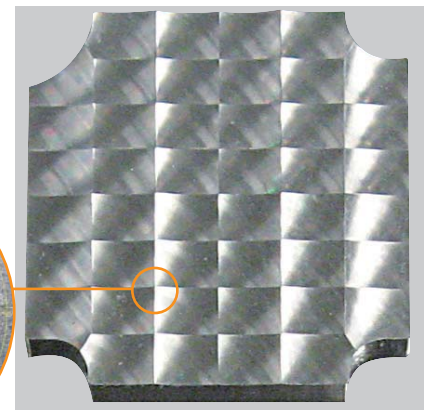
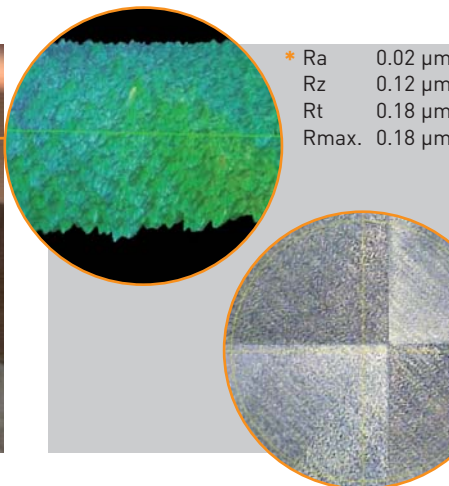
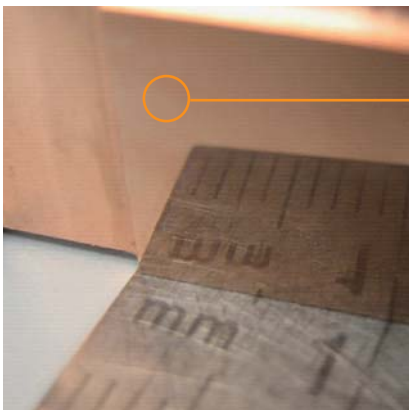

High-tech motor spindle

HSC core components from Step-Tec

Tool spindles for challenging machining tasks

Whatever machine configuration you choose, a MIKRON HSM/XSM LP machine gives you state-of-the-art tool spindle technology.

The facts

- Vector control for full torque in the lowest range
- Ultra-stable ceramic hybrid spindle bearings
- Spindle mantle cooling by means of a controlled coolant cycle for constant temperatures throughout working times
- Oil-air lubrication system with suction disposal of used oil
- Integrated "smart machine" sensors
- Cooling between tool interface and frontal spindle bearings in the Opticool spindles

You benefit from

- Precise high-performance
- Shorter acceleration phases
- High torque
- Thread cutting without compensation chuck

	30'000 min ⁻¹	42'000 min ⁻¹	54'000 min ⁻¹
HSM/XSM 400 LP	•	•	•
HSM/XSM 400U LP	•	•	•
HSM/XSM 500 LP	•	•	•
HSM LP Precision	•	•	



Step-Tec has developed, produced, sold and repaired precision high-performance spindles for leading manufacturers of machining centers for milling and drilling applications since 1995.



The delivered package includes the smart-machine module APS (Advanced Processing System) for reliable detection and display of vibrations during the milling process.

Tool magazine

Individual solutions tailored to your production needs

Tool automation in every configuration level

- Simple or double-row disc magazine
- Reliable "pick-up" changing system
- Feed control via light beam
- Capacity of up to 68 tools
- Tool lengths up to 200 mm*
- Tool diameters up to \varnothing 65 mm*
- Tool weights up to 1.2 kg*
- Orientation of the touch probe

Available model sizes:

HSK-E32 : 20; 40 tools

HSK-E40* : 18; 36; 68 tools



Double-row HSK-E40 magazine with a capacity of 68 tools



User-friendly tool feeding

Productivity and process reliability are ensured by lateral tool feeding

- Simultaneous machining and feeding
- Simple feed monitoring through large glass panel
- Ergonomic access

Chip and Dust management

Well thought-out machine concept for maximum autonomy

Vacuum removal of graphite



Equipment versions

Chip forms and volumes are determined by the work material and the machining strategy. The options offered range from a simple chip pan to versions with a coolant tank...



and chip flushing, ...

or with chip auger ...

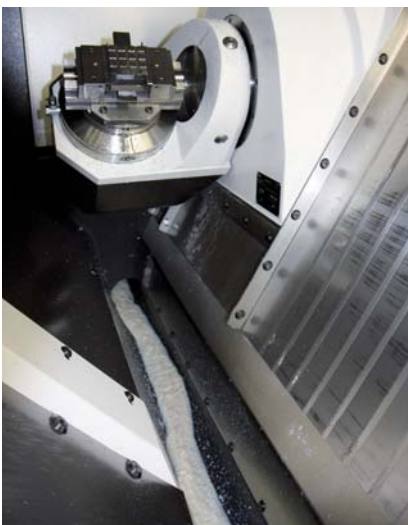

and lift-up chip conveyor. They come with or without a filter system.



Clean workspace

The interior of the MIKRON HSM/XSM LP machines is steeply inclined. The slanted sides help to optimise both the fall of chips and cleansing with flushing systems.

Chip disposal

Chip disposal should be handled automatically without any intervention by the operator. The key to successful automation is a good concept.

Option: ProdMod

Automated parts manufacture: 24/7

Thanks to its flexibility and reliability the MIKRON HSM/XSM ProdMod product series is a benchmark for automated production of high quality parts.

- Efficient management of chips
- Washing away system in the interior
- Feed of coolant through the middle of the spindle
- Extended tool-storage capacities (168x oder 308x)
- Integrated laser tool measuring system

Built to withstand tough production conditions

A flushing system reliably keeps the workspace doors free of chips.

* Cooling lubrication through the spindle (IKZ)

With IKZ you can bring the cooling lubricant with high process reliability to the tool cutter. Differing tool diameters do not require new alignment of the coolant hoses.

The purity of the lubricant is vital to the life cycle of the spindle. A filter system is therefore essential. ICS machining with a high-performance chip conveyor and a filter system solves the problem.

Extended tool magazine

The tool storage device is built as a circular hanger with 168 or 308 tool positions. The central gripper is separated from the delivery mechanism so that a short wait occurs when switching.

Time for changing tools: < 2 sec.

Time for preparing tools: < 10 sec.

* Available on demand.



Options

Tailor-made equipment



Cooling lubricant container



Lift-up chip conveyor



Chip flushing

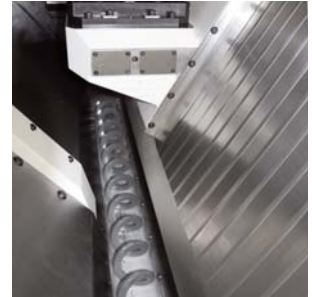

Spiral chip conveyor



High performance belt filter unit



Minimum quantity lubrication unit



Mist extraction system



Mist extraction system



Automation interface (closed)

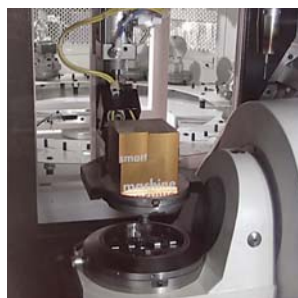

Automation interface (open)



Touch probe TI



smart machine Module
(www.gfac.com)

Further options:

- Rotating window
- Dust extraction system
- Beacon
- Laser tool measurement
- ITM (Intelligent Tool Measurement)
- ...

smart machine

The new dimension in modern production

Bringing intelligence into the milling process is the intended aim of "smart machine".

This includes a range of modules that are collectively referred to under the generic term "smart machine" and that fulfil various functions. In order to make the milling process "intelligent", various requirements have to be implemented.

First of all, establishing comprehensive communication between man and machine, which makes precise information that the operator requires to assess the milling process available to him. Secondly, supporting the operator in the optimisation of the process, which considerably improves the performance. Thirdly, the machine optimises the milling process, which improves the process safety and the quality of the workpiece - above all in unmanned operation.

The facts

- Greater accuracy in shorter machining times
- Increase in the workpiece surface quality as well as the surface and shape accuracy
- Recognition of critical machining strategies
- Improvement in the process safety
- Reduction of the machine set due to longer service life
- Higher availability
- Better operating comfort
- Considerable increase in reliability in unmanned operation

smart machine construction kit system

Each of the modules fulfils a specific task. Just like in a construction kit, the user can select the modules that seem to him to be the best option for improving his process.

Your benefit

Producing the workpieces in a process-secure and precise manner, increasing the reliability in unmanned operation, increasing the service life of the machine and significantly reducing production costs.



Protection



Precision



Productivity



The smart machine is constantly being further developed.

The currently available modules can be found at www.gfac.com



About GF AgieCharmilles

Milling

High-Speed and High-Performance Milling Centers

In terms of cutting speed, HSM centers are 10 times faster than conventional milling machines. Greater accuracy and a better surface finish are also achieved. This means that even tempered materials can be machined to a condition where they are largely ready to use. One essential advantage of HSM is that with systematic integration, the process chain can be significantly shortened. HSM has developed alongside EDM into one of the key technologies in mold and tool making.

EDM

Electric Discharge Machines

EDM can be used to machine conductive materials of any hardness (for example steel or titanium) to an accuracy of up to one-thousandth of a millimeter with no mechanical action. By virtue of these properties, EDM is one of the key technologies in mold and tool making. There are two distinct processes – wire-cutting EDM and die-sinking EDM.

Laser

Laser ablation

Laser ablation supplements and extends the technologies offered by GF AgieCharmilles. With our laser technology we enable you to produce texturizing, engraving, microstructuring, marking and labeling of 2D geometries right through to complex 3D geometries. Laser ablation, compared to conventional surface treatment using manual etching processes, offers economic, ecological and design advantages.

Customer Services

Operations, Machine and Business Support

Customer Services provides with three levels of support all kind of services for GF AgieCharmilles machines.

Operations Support offers the complete range of original wear parts and certified consumables including wires, filters, electrodes, resin and many other materials.

Machine Support contains all services connected with spare parts, technical support and preventive services.

Business Support offers business solutions tailored to the customer's specific needs.

Automation

Tooling, Automation, Software

Tooling for fixing workpieces and tools; automation systems and system software for configuring machine tools and recording and exchanging data with the various system components.

Contact

www.gfac.com

+GF+

AgieCharmilles

© Agie Charmilles SA, 2010
The technical data and illustrations are not binding.
They are not warranted characteristics and are subject to change.

Achieve more...