

5-Axis Vertical Machining Center  
**UNIVERSAL CENTER MU-400V II**

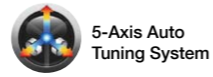

# 5-Axis Vertical Machining Center UNIVERSAL CENTER MU-400V II



## Okuma's 5-axis vertical—superb, multi-sided applications in one-chucking—when you also need fast and efficient parts production with high accuracies

The MU-400V II 5-axis vertical machining center is based on the ACE CENTER MB-V, which boasts exceptional thermal stability with the Thermo-Friendly Concept to control thermal deformation using the unique concept of accepting temperature changes. With a trunnion structure rotary table, the MU-400V II achieves high speed, high accuracy 5-axis machining. —Quick positioning, swift ATC, and other standard features give the base machine outstanding performance. Okuma just added a trunnion with superb positioning accuracy, rigidity, and top-of-the-class table rotation speed.

From aerospace components that require simultaneous 5-axis machining to one-chuck multi-sided operations (vastly reduced setups), the Universal Center is the right tool for a wide variety of workpieces.

### Hypoid gears provide fast and accurate machining with 2-axis trunnion table

- Rotation C axis: 50 min<sup>-1</sup> (300 deg/sec)  
A axis: 40 min<sup>-1</sup> (240 deg/sec)
- Indexing A/C axes: ±4 sec\*
- Repeatability A/C axes: ±1 sec\*
- Minimum indexing angle 0.0001° \*Actual data

### One-chucking multi-sided machining

- Eliminates extra clamps
- Improves machined workpiece accuracies
- Eliminates setup changes  
Keeps costs down, provides highly efficient production

### Superb thermostability

- Thermo-Friendly Concept



Photos shown in this brochure may also show optional equipment.

# Reliable technology that supports fast, high-quality machining

## Solid trunnion construction permits fast and accurate machining

- Rotation range**
    - C axis: 360 degrees
    - Axis: +20 to -110 degrees
  - Maximum workpiece size**
    - $\phi 600 \times h400$  mm ( $\phi 23.62 \times \phi 15.75$  in.)
    - [See details on page 8.]
  - Maximum load**
    - 300 kg (660 lb)
  - High accuracies**
    - Indexing:  $\pm 4$  sec (A/C axes)\*
    - Repeatability:  $\pm 1$  sec (A/C axes)\*
    - High-precision ground gears used (heat-treated steel—excellent durability)
    - With high-precision DD encoders.
  - High speeds**
    - C axis:  $50 \text{ min}^{-1}$  (300 deg/sec)
    - A axis:  $40 \text{ min}^{-1}$  (240 deg/sec)
    - Driven by hypoid gears
- \* Actual data

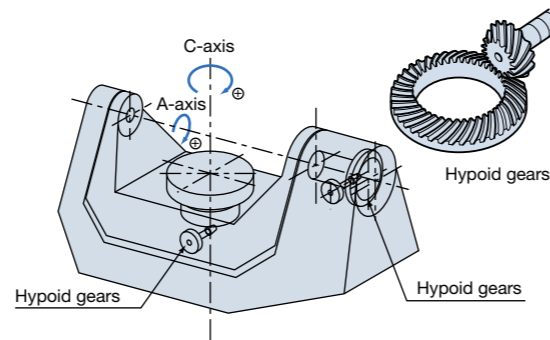

## Spindle specs available to match your application requirements

- For general applications**
  - Standard Spindle  $8,000 \text{ min}^{-1}$ , 11/7.5 kW (15/10 hp) (10 min/cont) 198 N-m (146 ft-lbf) (BT40)
- Fast/efficient aluminum and light alloy applications**
  - Wide-Range Spindle (Optional)  $15,000 \text{ min}^{-1}$ , 22/18.5 kW (30/25 hp) (10 min/cont) 199 N-m (146 ft-lbf) (BT40)
  - High-Speed Spindle (Optional)  $20,000 \text{ min}^{-1}$ , 30/22 kW (40/30 hp) (10 min/cont) 57 N-m (42 ft-lbf) (HSK-A63)
- High-speed machining of die/molds and small precision parts**
  - High-Speed Spindle (Optional)  $25,000 \text{ min}^{-1}$ , 15/11 kW (20/15 hp) (10 min/cont) 29 N-m (21 ft-lbf) (HSK-A63)
  - $35,000 \text{ min}^{-1}$ , 15 kW (20 hp)(cont) 4 N-m (3 ft-lbf) (HSK-F63)

## Superior machine structure

- Thermo-Friendly Construction**
  - Thermally symmetric and with "box-build" structure
  - Cooling unit and NC control box designed to dissipate heat
  - Thermally balanced structure
  - Structure that isolates heat from coolant and chips
- Extremely rigid machine construction**
  - From extended use of the advanced 3D-CAD and FEM analysis
  - With ram-saddle feed
- Easy to use**
  - Good visibility of the machining process
  - Good table access

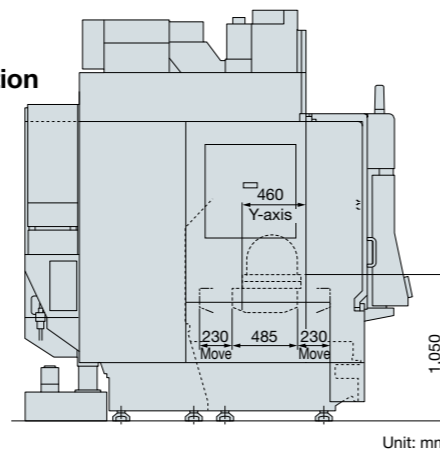

Unit: mm

## The unique approach of "accepting temperature changes" Thermo-Friendly Concept

### Thermo-friendly structure gives outstanding thermal stability

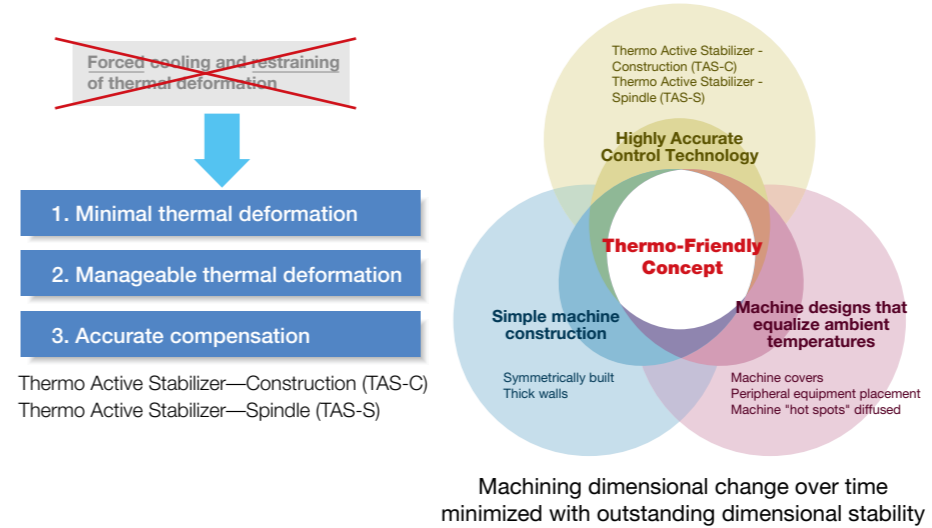

### Eliminate waste with the Thermo-Friendly Concept

In addition to maintaining high dimensional accuracy when room temperature changes, Okuma's Thermo-Friendly Concept provides high dimensional accuracy during machine startup and machining restart. To stabilize thermal deformation, warming-up time is shortened and the burden of dimensional correction during machining restart is reduced.

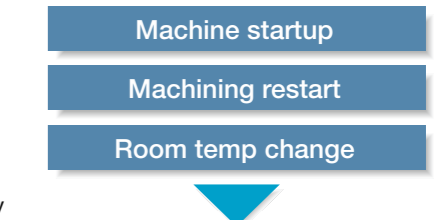

### High dimensional stability

#### TAS-C (Thermo Active Stabilizer—Construction) [Optional]

The TAS-C environmental thermal deformation control accurately controls the machine's structural thermal deformation; by taking into consideration the machine's thermal deformation characteristics, temperature data from properly placed sensors, and feed axis positioning information.

#### Machine tool idling stop ECO Idling Stop

Only the necessary units run

#### Accuracy ensured, cooler off ECO Idling Stop

Intelligent energy-saving function with the Thermo-Friendly Concept. The machine itself determines whether or not cooling is needed and cooler idling is stopped with no loss to accuracy. (Standard application on machines with Thermo-Active Stabilizer—Spindle)

#### On-the-spot check of energy savings ECO Power Monitor

Power is shown individually for spindle, feed axes, and auxiliaries on the OSP operation screen. The energy-saving benefits from auxiliary equipment stopped with ECO Idling Stop can be confirmed on the spot.

#### TAS-S (Thermo Active Stabilizer—Spindle) [Optional]

The TAS-S spindle thermal deformation control takes into account various conditional changes such as the spindle's temperature data, modification of the spindle rotation and speed, as well as spindle stoppage. The spindle's thermal deformation will be accurately controlled, even when the rotating speed changes frequently.

#### ECO suite benefits

Electricity consumption during non-machining time greatly reduced with "ECO Idling Stop", which shuts down each piece of auxiliary equipment not in use.

#### ECO suite provides a suite of energy-saving functions that can be used on machines

- "ECO Idling Stop" for operation of necessary units only
- "ECO Power Monitor" for visual graphics of power
- Intermittent/continuous operation of chip conveyor and mist collector during operation — "ECO Operation" (Optional)
- Energy-saving hydraulic unit using servo control technology — "ECO Hydraulics" (Optional)

**ECO suite**

# Highly efficient 5-axis machining of complex-shaped parts

Increased productivity with robust machining capacity

**602 cm<sup>3</sup>/min** (actual data\*)

ø20 roughing end mill, workpiece material: S45C

Wide range spindle (Optional) 15,000min<sup>-1</sup> (No. 40 22/18.5 kW 199/146 N-m)

Cutting Tool	Spindle min <sup>-1</sup>	Cutting m/min	Feed mm/min	Width mm	Depth mm	Removed cm <sup>3</sup> /min
ø80 (ø3.15) face mill 8 blades (cermet)	895	225	3,000	56	3	<b>504</b>
ø20 (ø0.79) roughing end mill 7 flutes (carbide)	4,000	251	4,300	7	20	<b>602</b>
ø63 (ø2.48) insert drill (carbide)	606	120	91	—	—	—
M30 P3.5 tap	318	30	1,113	—	—	66% (Spindle load)

\* Note: The "actual data" referred to above for this brochure represent examples, and may not be obtained due to differences in specifications, tooling, and cutting conditions.

## Standard spindle

For general applications

- Speed . . . . . 8,000 min<sup>-1</sup>
- Max output . . . . . 11/7.5 kW (10 min/cont)
- Max torque . . . . . 198/135 N-m (5 min/cont)

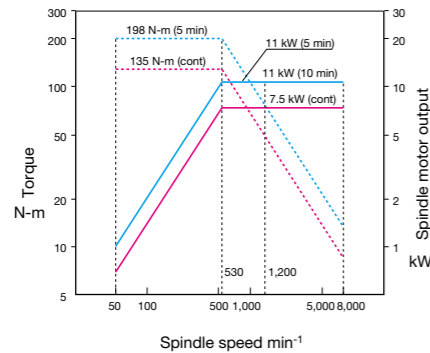

## Wide-range spindle (Optional)

Highly efficient light alloys (Al)

- Speed . . . . . 15,000 min<sup>-1</sup>
- Max output . . . . . 22/18.5 kW (10 min/cont)
- Max torque . . . . . 199/146 N-m (5 min/cont)

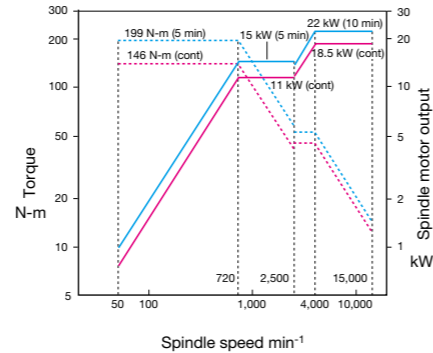

## Quick machine components reduce non-cutting times

- Rapid traverse . . . . . X-Y: 40 m/min (1,575 ipm)
- Rapid accel/decel spindle . . . 1.2 sec (0 ↔ 8,000 min<sup>-1</sup>)
- Rapid ATC . . . . . 1.2 sec (T-T)

### Hi-G Control (standard)

During positioning, this function controls the acceleration/deceleration speed according to the speed- torque characteristics of the BL motor, resulting in fast and highly stable positioning. The Hi-G control function reduces positioning time and greatly reduces non-cutting time.

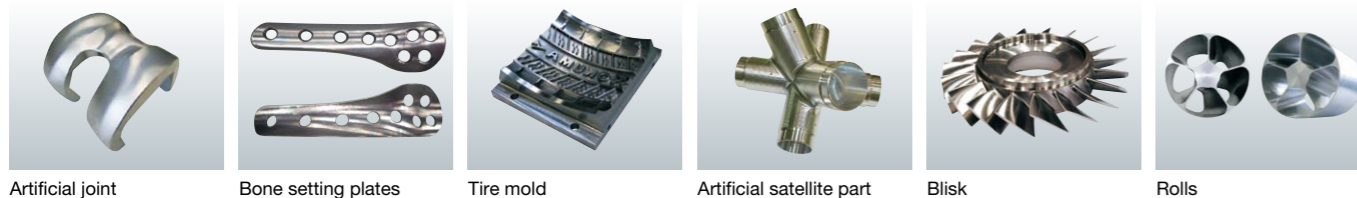
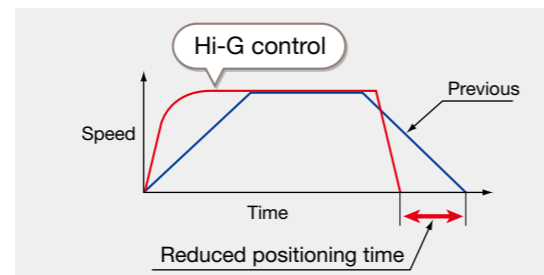

Artificial joint    Bone setting plates    Tire mold    Artificial satellite part    Blisk    Rolls

# Power displayed in indexing and simultaneous 5-axis machining

5-axis indexing/simultaneous 5-axis operation provides high-quality machining

## 3-axis vs 5-axis machining

□ : 3-axis    □ : 5-axis

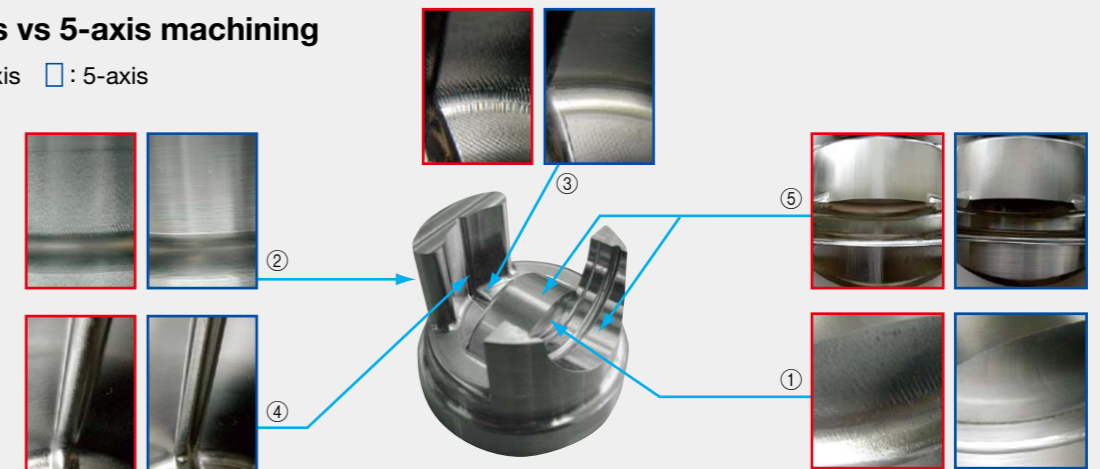

- Machine MU-400V II 15,000 min<sup>-1</sup>
- Workpiece Rubber mold
- Material NAK80
- Work size ø100 × 75
- Data Unigraphics

Advantages	Application Used
① Can cut pin corners	Workpiece oriented (positioned) to ideal cutting conditions
② Perpendicular wall (H45 mm) vibration eliminated	Shorter tool lengths for tools with higher rigidity
③ Corner R vibration eliminated	
④ Can use smaller-dia tools (ø6 → ø3 mm)	Tip-clear* ball-nose end milling
⑤ Higher quality cuts; concave bottom (convex top)	

\* 0 peripheral speed

## Cutting conditions

Area machined	Tool	Spindle speed min <sup>-1</sup>	Cutting speed m/min	Feedrate mm/min
Half cylinder	ø16 end mill	4,000	215	400
Center cylinder	ø4 ball end mill	10,000	125	1,500
All corners	ø3 ball end mill	8,000	75	1,000
Cylinder groove	ø1.5 ball end mill	12,000	55	1,500

## Intensive machining—in one chucking



- Machine MU-400V II 15,000 min<sup>-1</sup>
- Workpiece Bone setting plate
- Material Ti-6Al-4V (titanium alloy)
- Work size 117 × 30 × 3
- Cycle time 9 hr 5 min (machining from block material)

## Cutting conditions

Area machined	Tool	Spindle speed min <sup>-1</sup>	Cutting speed m/min	Feedrate mm/min
Roughing (all surfaces)	ø20 R2 corner radius end mill	954	60	763
Both surfaces	R5 ball end mill	3,180	100	318
ø7 hole	ø7 drill	909	20	64

## Machine specifications

Item	Unit	MU-400V II	
Travels	X-axis (saddle left/right)	mm (in.)	762 (30.00)
	Y-axis (pallet front/back)	mm (in.)	460 (18.11)
	Z-axis (spindle up/down)	mm (in.)	460 (18.11)
	A-axis	deg	+20 to -110
	C-axis	deg	360
	Table surface to spindle nose	mm (in.)	100 to 560 (3.94 to 22.05)
Table	Table size	mm (in.)	ø400 (ø15.75)
	Max work size	mm (in.)	ø600 x h400 (ø23.62 x h15.75) *For details see p.8
	Floor to table top	mm (in.)	1,050 (41.34)
	Max load capacity	kg (lb)	300 (660)
Spindle	Spindle speed	min <sup>-1</sup>	8,000 [15,000, 20,000, 25,000, 35,000]
	No. of spindle ranges		Infinitely variable
	Tapered bore		7/24 taper No. 40 [HSK-A63, HSK-F63]
	Bearing dia	mm	ø70 [ø70, ø60]
Feed	Rapid traverse	m/min (ipm)	X-Y: 40 (1,575) Z: 32 (1,260)
	Rapid traverse (A-C)	deg/min	A: 14,400 C: 18,000
	Cutting feedrate	mm/min (ipm)	X-Y-Z: 32,000 (1,260)
Motors	Spindle (10 min/cont)	kW (hp)	11/7.5 (15/10) [22/18.5, 30/22, 15/11, 15]
	Feed axes	kW	X-Y-Z: 3.5 A: 4.2 C: 3.0
ATC	Tool shank		MAS BT40 [HSK]
	Pull stud		MAS 2 [-]
	Tool capacity	tools	20 [32, 48, 64, 98, 132, 166, 200, 234, 268]*
	Max tool dia (w/ adjacent tool)	mm (in.)	ø90 (ø3.54)
	Max tool dia (w/o adjacent tool)	mm (in.)	ø125 (ø4.92)
	Max tool length	mm (in.)	240 (9.45)
	Max tool weight	kg (lb)	8 (18)
	Max tool moment	N-m (ft-lbf)	7.8 [8 kg x 100 mm] (5.7 [17.6 lb x 3.94 in.])
Tool selection		Memory random [fixed address for matrix type for ≥64 tools]	
Machine size	Height	mm (in.)	2,946 (115.98)
	Floor space W x D	mm (in.)	2,160 x 2,810 (85.04 x 110.63)
	Weight	kg (lb)	8,300 (18,260)

\* Matrix type for ≥64 tools [ ] Optional

## Standard specifications / accessories

Item	Remarks	Item	Remarks
Spindle speed 50 to 8,000 min <sup>-1</sup>	7/24 taper No. 40, 11/7.5 kW (15/10 hp)	Chip pan	Effective capacity: 60 L
Rapids X-Y: 40, Z: 32 m/min	(X-Y: 1,575, Z: 1,260 ipm)	ATC air blower (blast)	
Spindle/Spindlehead cooling system	Oil controller	Chip air blower (blast)	Nozzle type
Air cleaner (filter)	Including regulator	Foundation blocks (with jack bolts)	8 pcs (with jack bolts)
Spindle oil-air lubrication system		3-lamp status indicator	Type C (LED signal tower)
A/C axis rotary table	0.0001 deg, includes DD encoders	Work lamp	LED
C axis table	ø400, T groove 18H7 6-tool	Full enclosure shielding	With ceiling
Auto tool changer	20-tool	Tapered bore cleaning bar	
ATC magazine shutter		Hand tools	
ATC magazine shutter		Tool box	
Coolant supply system*1	Tank: 170 L [Effective: 100 L], pump: 250W	CNC	OSP-P300M
Coolant nozzle	Flexible nozzle 5-tool	Operation panel with color LCD	
Chip flusher system*2	Table left/right	Pulse handle	

\*1. 800-W pump required with oil-based coolant.

\*2. Use an in-machine coil type chip conveyor when using an oil-based coolant.

Note: Oil-based coolants are highly flammable, so fire prevention measures must always be taken when using these coolants. Do not operate unattended.

## Working range

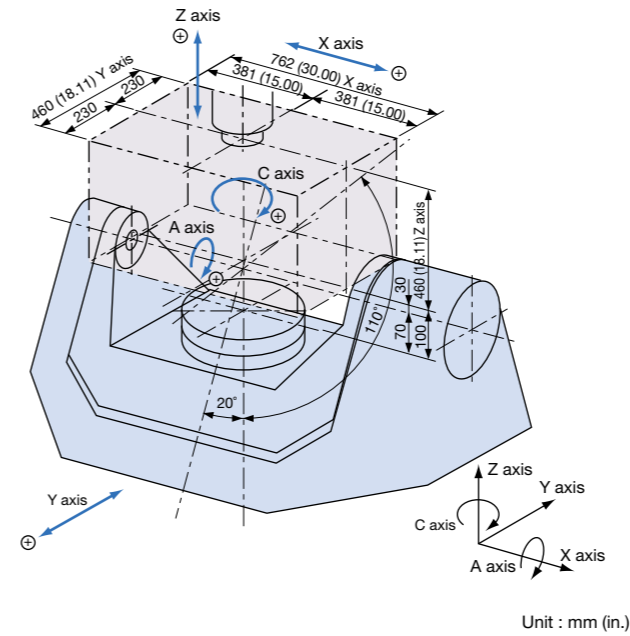

## Max workpiece dimensions

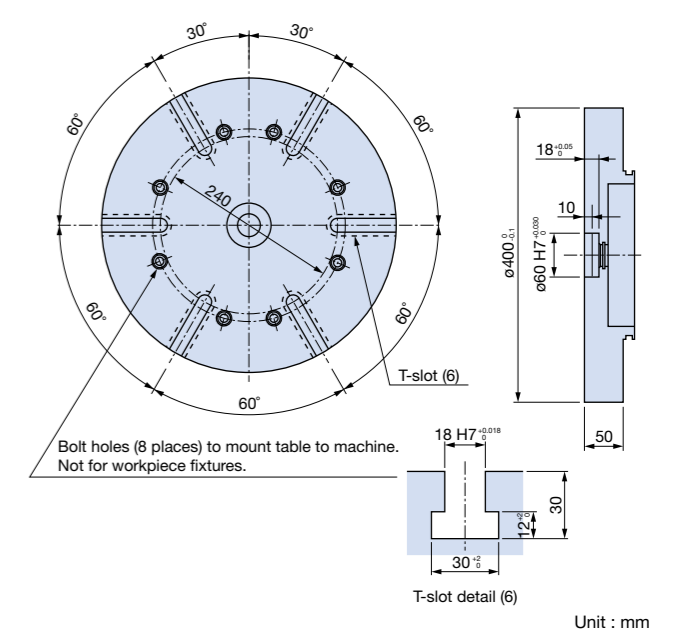

## Table dimensions

(A axis at -90° swing)

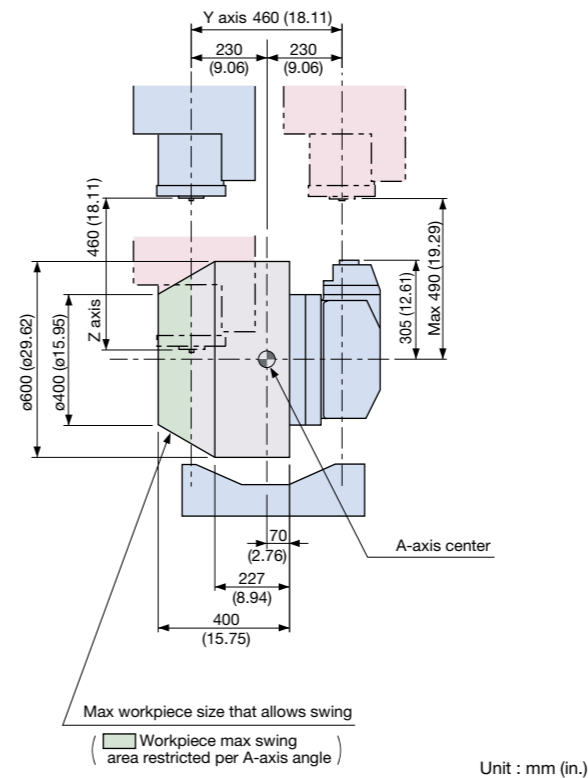

## Maximum tool dimensions

### Maximum tool size (adjacent tools)

Maximum tool dimension that can be used alongside the magazine.

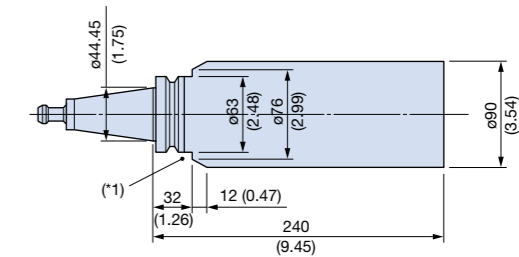

### Max single tool size

Maximum tool size that can be used when there are no adjacent tools on either side in the ATC magazine

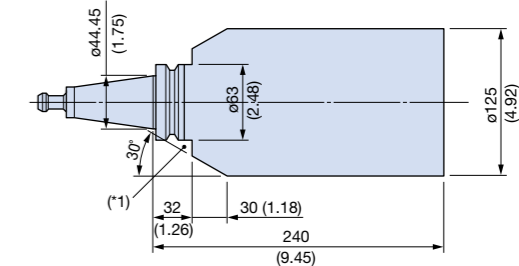

\*1. With commercially available milling chucks, interference between the ATC arm and milling outer diameter may occur. Always be sure to check the dimensions in the catalog or other data sources from the tool manufacturer before use.

### ATC maximum tool mass moment

Mass including shank may be up to 78.4 N (8 kg), and the center of gravity position at that time up to 100 mm from gauge line.

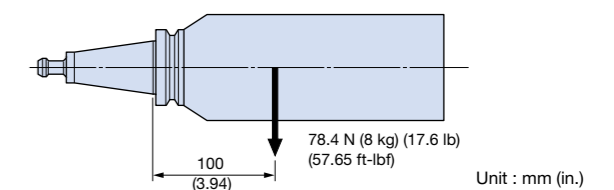

## Optional specifications / accessories

Item	Remarks	Item	Remarks
Optional spindle speeds		Mist collector	
Wide-range spindle 50 to 15,000 min <sup>-1</sup> *	22/18.5 kW (30/25 hp) [10 min/cont]* <sup>1</sup>	Semi-dry machining	
High-speed spindle 50 to 20,000 min <sup>-1</sup> *	30/22 kW (40/30 hp) [10 min/cont]* <sup>2</sup>	Shower coolant	
High-speed spindle 50 to 25,000 min <sup>-1</sup> *	15/11 kW (20/15 hp) [10 min/cont]* <sup>2</sup>	Workpiece washing gun	
High-speed spindle 35,000 min <sup>-1</sup> *	15 kW (20 hp) [cont], HSK-F63	In-machine chip conveyor (coil) *	Table left/right
Dual contact spindle	HSK, BIG-PLUS®, Super BT	Lift-up chip conveyor *	With reference to recommended chip discharge on p. 10, right side discharge (rear discharge also possible)
Special ATC capacities	32-tool, 48-tool (chain system)	Chip bucket for above *	
	64, 98, 132, 166, 200, 234, 268-tool (matrix system)	Dust collector	
Special pull studs	MAS 1 · JIS · CAT · DIN	Tool breakage detection/Auto tool length compensation	Touch sensor (Metrol)
Attachment preps	Accelerator attachment	Auto zero offset/Auto gauging	Touch probe (Renishaw)
	Anglehead attachment	5-Axis Auto Tuning System	Gauging compensation of geometric error
	Oil hole supply	Chemical anchor specs	
AbsoScale	X-Y-Z	Hydraulic fixture preps <sup>*3</sup>	Hydraulic: 2 tools, air: 2 tools
Die/mold & fine-feed specs	Rapid traverse X-Y-Z: 20 m/min	Work lamp	LED Left side mount
Thru-spindle coolant	** Specify 1.5 MPa or 7.0 MPa	TAS-S	Thermo Active Stabilizer–Spindle
	25,000 min <sup>-1</sup> specs for HSK-A63 only	TAS-C	Thermo Active Stabilizer–Construction
APC			
Chip air blower (adapter)			
Oil mist coolant			

\* Corresponding standard specifications are deleted. \*\* Okuma pull studs required. (End-face grinding, O-ring, and through-hole diameter differ from those of commercial pull studs.)

\*1. Spindle taper (7/24 No. 40) accepts (BT40, BIG-PLUS®, SuperBT, CAT 40, DIN 40) or HSK-A63. \*2. Spindle taper accepts BIG-PLUS®, SuperBT or HSK-A63.

\*3. Cannot accommodate auto pallet changer

## High-speed spindle (Optional)

### Die/mold and aluminum applications

- Speed . . . . . 20,000 min<sup>-1</sup>
- Max output . . . 30/22 kW (10 min/cont)
- Max torque . . . 57/42 N-m (10 min/cont)

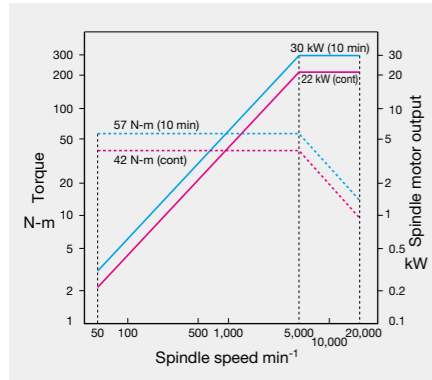

### Die/mold and small precision parts

- Speed . . . . . 25,000 min<sup>-1</sup>
- Max output . . . 15/11 kW (10 min/cont)
- Max torque . . . 29.1/19.9 N-m (10 min/cont)

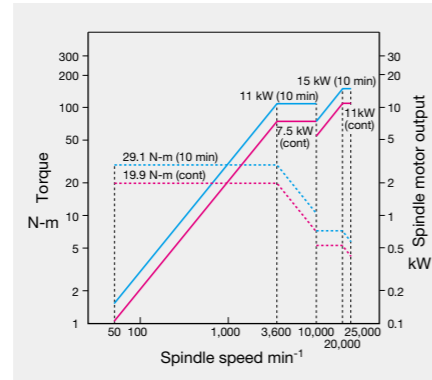

- Speed . . . . . 35,000 min<sup>-1</sup>
- Max output . . . 15 kW (cont)
- Max torque . . . 4 N-m

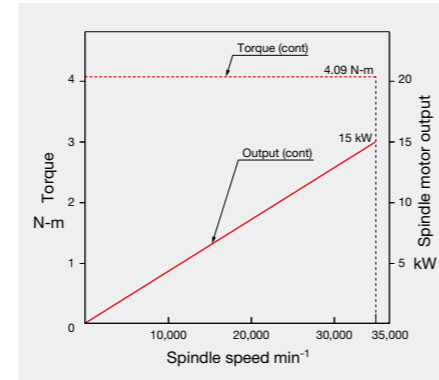

## Major options

- Shower coolant/ Coolant nozzle
- Tool breakage detection/ Auto tool length compensation
- Auto zero offset/Auto gauging (optical transmission)



## In-machine chip discharge (coil type: Optional)

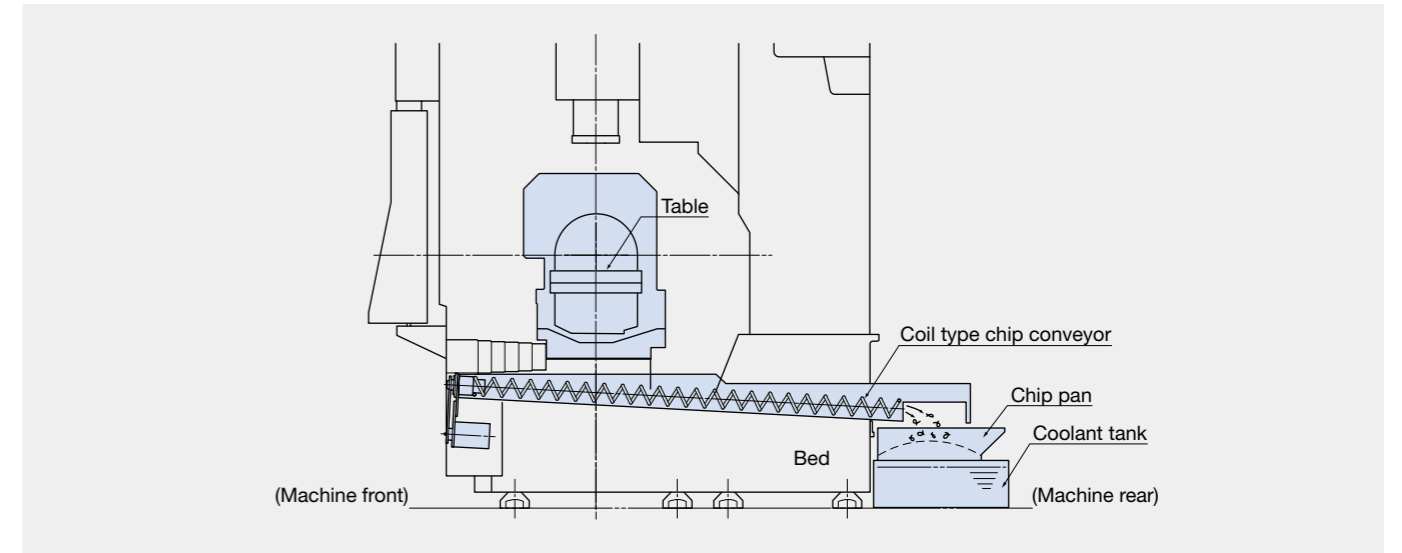

## Recommended Chip Conveyors

(Please contact an Okuma sales representative for details.)

○: Recommended  
△: Recommended with conditions

Workpiece material		Steel	FC	Aluminum / Nonferrous	Mixed (general use)
Chip shape					
In-machine	Screw (Standard)	—	○ (Wet)	○	—
	Coil (Optional)	○	○ (Dry-Wet)	—	○
Off-machine (Optional)	Hinge	○	—	—	△ (*4)
	Scraper	—	○ (Dry)	—	—
	Scraper (with drum filter)	—	○ (Wet) with magnet	△ (*3)	—
	Hinge + scraper (with drum filter)	△ (*1)	△ (Wet) (*2)	○	○

\*1. When there are many fine chips \*2. When chips are longer than 100 mm \*3. When chips are shorter than 100 mm \*4. When there are few fine chips  
Note: Use of oil-based coolant may cause fires; fire prevention measures are necessary.

## Off-machine lift-up chip conveyors

Name	Hinge	Scraper	Scraper (with drum filter)	Hinge + scraper (with drum filter)
Shape				



# The Next-Generation Intelligent CNC *OSP suite OSP-P300M*

It is a suite of premium applications to increase the efficiency of each manufacturing process by increasing status visibility and digitizing shop floor production instructions, setup information, machining and utilization, machine maintenance information and more. Intelligent, fast machining and efficient “monozukuri” (craftsmanship-based manufacturing) achieved with a control interface that can be operated on a new dimension.

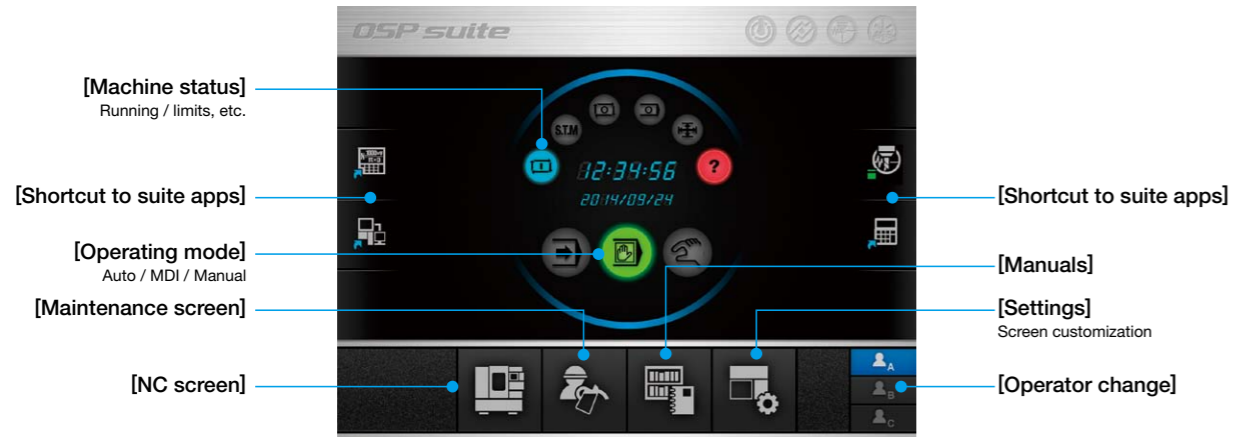

## ■ suite apps

In addition to Okuma's Intelligent Technology, a rich array of applications is available for visualization and digitization of information needed on shop floors to support high-level “monozukuri”.

PERIODICAL MAINTENANCE		DAILY INSPECTION		CHANGE MODE		
NO	ITEM	WORK	PROGRESS	REMAIN	INFO	EXECUTE
310	Ceases for tool clamping unit (HS)	Supply	5%			
311	Packing in tool clamping unit (HS)	Inspection	50%			
320	5-axis contour lubrication oil	Replace	100%			
411	Hydraulic unit oil	Replace	0%			
412	Hydraulic unit line filter	Cleaning	1%			
413	Hydraulic unit line filter	Replace	50%			
421	Oil for SPCL cooling unit	Replace	100%			

Maintenance Monitor that displays daily and regular check items

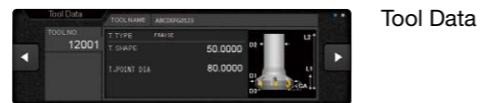

## ■ suite operation

A highly reliable touch panel suited to shop floors is used. Suite apps can be started by touching a function key icon on the right side of the screen. They are then displayed in a pop-up window. The icon layout is customizable. Suite apps can be accessed with one touch according to the desired phase of operation.

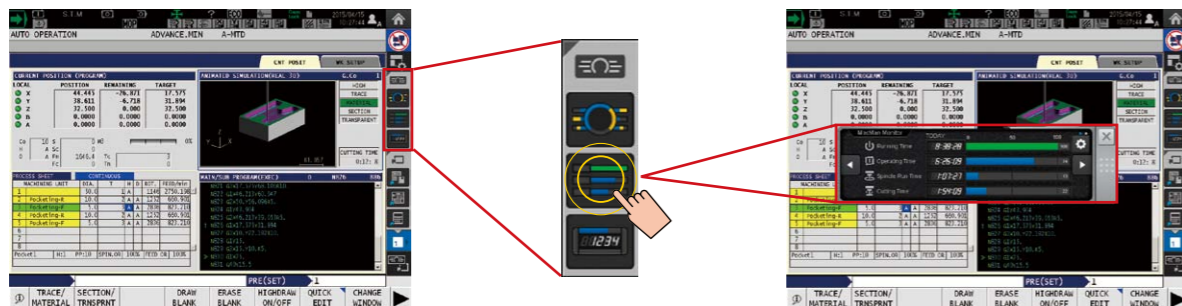

## ■ Standard Specifications

Basic Specs	Control	X, Y, Z, A, C simultaneous 5-axis, spindle control (1 axis)
	Position feedback	OSP full range absolute position feedback (zero point return not required)
	Coordinate functions	Machine coordinate system (1 set), work coordinate system (20 sets)
	Min / Max inputs	8-digit decimal, ±99999.999 to 0.001 mm (3937.0078 to 0.0001 in.), 0.001° Decimals: 1 μm, 10 μm, 1 mm (0.0001, 1 in.) (1°, 0.01°, 0.001°)
	Feed	Override: 0 to 200%
	Spindle control	Direct spindle speed commands override 30 to 300%, multi-point indexing
	Tool compensation	No. of registered tools: Max 999 sets, tool length/radius compensation: 3 sets per tool
	Display	15-inch color LCD + touch panel operations
	Self-diagnostics	Automatic diagnostics and display of program, operation, machine, and NC system faults
	Programming	Program capacity
Program operations		Program management, editing, multitasking, scheduled program, fixed cycle, G-/M-code macros, arithmetic, logic statements, math functions, variables, branch commands, coordinate calculate, area calculate, coordinate convert, programming help, fixture offset II
Operations	suite apps	Applications to graphically visualize and digitize information needed on the shop floor
	suite operation	Highly reliable touch panel suited to shop floors. One-touch access to suite apps.
	Easy Operation	“Single-mode operation” to complete a series of operations. Advanced operation panel/graphics facilitate smooth machine control
	Machine operations	MDI, manual (rapid traverse, manual cutting feed, pulse handle), load meter, operation help, alarm help, sequence return, manual interrupt/auto return, pulse handle overlap, parameter I/O, PLC monitor, alignment compensation
MacMan	Machining management: machining results, machine utilization, fault data compile & report, external output	
Communications / Networking	USB (2 ports), Ethernet, RS-232-C interface (1 channel)	
High speed/accuracy specs	Hi-Cut Pro, pitch error compensation, Hi-G Control, SERVO NAVI, Machining Time Shortening Function	
Energy-saving	ECO suite	ECO Idling Stop*1, ECO Power Monitor*2

\*1. Spindle cooler Idling Stop is used on TAS-S machines.

\*2. The power display shows estimated values. When precise electrical values are needed, select the on-machine wattmeter option.

## ■ Optional Specifications

Item	Kit Specs <sup>1</sup>	NML			3D			AOT		
		E	D	E	D	E	D	E	D	
<b>Interactive functions</b>										
Advanced One-Touch IGF-M (Real 3D simulation)										
Interactive MAP (I-MAP)										
<b>Programming</b>										
Auto scheduled program update										
Common variables	1,000 pts									
(Std: 200 pts)	2,000 pts									
Program branch; 2 sets										
Program notes (MSG)										
Coordinate system	100 sets									
select	200 sets									
(Std: 20 sets)	400 sets									
Helical cutting (within 360°)										
3D circular interpolation										
Synchronized Tapping II										
Arbitrary angle chamfering										
Cylindrical side facing										
Slope machining										
Inverse time feed										
Tool grooving (flat-tool free-shaped grooving)										
Tool center point control II (TCP-II) (w/ tool tilt comp)										
Tool tilt command										
Tool max rotational speed setting										
F1-digit feed	4 sets, 8 sets, parameter									
Programmable travel limits (G22, G23)										
Skip (G31)										
Axis naming (G14)										
Additional G/M code macros										
3D tool compensation										
Tool wear compensation										
Drawing conversion	Programmable mirror image (G62)									
	Enlarge/reduce (G50, G51)									
User task 2	I/O variables (16 each)									
Tape conversion*										
<b>Monitoring</b>										
Real 3D simulation										
Simple load monitor	Spindle overload monitor									
NC operation monitor	Hour meter, work counter									
Hour meters	Power, spindle, NC, cutting									
Operation end buzzer	M02, M30, and END commands									
Work counter	With M02 and M30 commands									
MOP-TOOL	Adaptive control, overload monitor									
Tool life management	Hour meter, No. of workpieces									
<b>Gauging</b>										
Auto gauging	Touch probe (G31)									
Auto zero offset	Includes auto gauging									
Tool breakage detection	(touch sensor) (G31)									
	Includes auto tool offset									
Gauging data printout	File output									
Manual gauging (w/o sensor)										
Interactive gauging (touch sensor, touch probe required)										
<b>External I/O communication</b>										
Additional RS-232-C channel (Std specs include 1 channel)										
DNC-T3										
DNC-B (232C-Ethernet transducer used on OSP side)										
DNC-DT										
DNC-C/Ethernet										
Additional USB (Additional 2 ports, Std: 2 ports)										
<b>Automation / untended operation</b>										
Auto power shut-off	M02 and END alarms, work preps done									
Warm-up (calendar timer)										
External program select	Button, rotary switch, digital switch, BCD (2-digit, 4-digit)									
Cycle time reduction (Ignores certain commands)										
Pallet pool control (PPC) (Required for multi-pallet APC)										
Robot, loader I/F										
<b>High-speed, high-precision</b>										
AbsoScale detection	X-, Y-, Z-axis									
5-Axis Auto Tuning System	Standard, high spec									
Straightness compensation										
0.1 μm control (linear axis commands)										
Super-NURBS										
Simultaneous 5-axis kit	Tool center point control II (w/tool tilt comp)									
	Tool center point control manual feed									
	Table origin coord manual feed									
	Super-NURBS (5-axis spec)									
	Slope machining									
	Inverse time feed									
	Tool tilt command									
	DNC-DT									
TAS-S (Thermo Active Stabilizer-Spindle)										
TAS-C (Thermo Active Stabilizer-Construction)										
<b>ECO suite (energy saving functions)</b>										
ECO Operation										
ECO Power Monitor	Wattmeter									
Energy-saving hydraulic unit	Inverter									
ECO Hydraulics										
<b>Other</b>										
Control cabinet lamp (inside)										
Circuit breaker										
Sequence operation	Sequence stop									
Upgraded sequence restart	Mid-block return									
Tool point center manual feed										
Table reference coord manual feed										
Pulse handle	2 pcs, 3 pcs (Std: 1 pc)									
External M signals	4, 8 signals									
Collision Avoidance System (CAS)										
Machining Navi M-i, M-gII+ (cutting condition search)										
One-Touch Spreadsheet										
Block skip; 3 sets										
Leading edge offset										
OSP-VPS (Virus Protection System)										

\*1. NML: Normal, 3D: Real 3D simulation, E: Economy, D: Deluxe,

AOT: Advanced One-Touch IGF-M

\*2. ★Technical consultation needed for specifications



When using Okuma products, always read the safety precautions mentioned in the instruction manual and attached to the product.

● The specifications, illustrations, and descriptions in this brochure vary in different markets and are subject to change without notice.  
Pub No. MU-400VI-E-(15a)-400 (Jan 2016)

This product is subject to the Japanese government Foreign Exchange and Foreign Trade Control Act with regard to security controlled items; whereby Okuma Corporation should be notified prior to its shipment to another country.



**OKUMA Corporation**

Oguchi-cho, Niwa-gun,  
Aichi 480-0193, Japan  
TEL: +81-587-95-7825 FAX: +81-587-95-6074